

**Vecow**

# **SPC-2000 USER MANUAL**

**Ultra-Compact, Rugged, Extended Temp, Fanless Embedded System  
with Quad Core Intel® Atom™ E3845 Processor**

**1.30 Edition,  
Jun., 06, 2023**



**Vecow Co., Ltd. Headquarters**

12F No 111 Zhongcheng Rd  
Tucheng Dist New Taipei City 23674 Taiwan (R.O.C.)  
Tel: +886-2-2268 5658 Fax: +886-2-2268 1658

Worldwide Technical Support and Product Info. [www.vecow.com](http://www.vecow.com)

© 2021 Vecow Co., Ltd. All rights reserved.

**All information is subject to change without notice.**

---

For further support information, refer to the Technical Support and Professional Services appendix. To comment on Vecow Co., Ltd. documentation, refer to the Vecow Co., Ltd. web site at [www.vecow.com](http://www.vecow.com).

## Record of Revision

---

Version	Date	Page	Description	Remark
1.00	10/22/2014	All	Preliminary Release	
1.10	07/24/2015	All	Update Release	
1.20	03/22/2021	25	Update Release	
1.30	06/06/2023	14, 61	Update Release	

## Disclaimer

This manual is intended to be used as a practical and informative guide only and is subject to change without prior notice. It does not represent commitment from Vecow Co., Ltd. Vecow shall not be liable for direct, indirect, special, incidental, or consequential damages arising out of the use of the product or documentation, nor for any infringements upon the rights of third parties, which may result from such use.

## Declaration of Conformity

### FCC

This equipment has been tested and found to comply with the limits for a Class A digital device, pursuant to part 15 of the FCC Rules. These limits are designed to provide reasonable protection against harmful interference when the equipment is operated in a commercial environment. This equipment generates, uses, and can radiate radio frequency energy and, if not installed and used in accordance with the instruction manual, may cause harmful interference to radio communications. Operation of this equipment in a residential area is likely to cause harmful interference in which case the user will be required to correct the interference at his own expense.

### CE

The product(s) described in this manual complies with all applicable European Union (CE) directives if it has a CE marking. For computer systems to remain CE compliant, only CE-compliant parts may be used. Maintaining CE compliance also requires proper cable and cabling techniques.

## Copyright and Trademarks

This document contains proprietary information protected by copyright. All rights are reserved. No part of this document may be reproduced by any mechanical, electronic, or other means in any form without prior written permission of the manufacturer. Company/product names mentioned herein are used for identification.

## Order Information

Part Number	Description
SPC-2845	Ultra-compact Embedded System, 2 PoE+ GbE LAN, 1 DVI-I, 4 RS-232/422/485, 8 Isolated DIO, 4 USB3.0, Onboard Quad Core Intel® Atom™ E3845 Processor
SPC-2145	Ultra-compact Embedded System, 2 GbE LAN, 1 DVI-I, 4 RS-232/422/485, 4 USB 3.0, Onboard Quad Core Intel® Atom™ E3845 Processor

## Optional Accessories

Part Number	Description
DDR3L8G	Certified DDR3L-1333 8G RAM
DDR3L4G	Certified DDR3L-1333 4G RAM
M340L-W28M1	Vecow DDR3L 4GB 1333/1066MHz RAM, Micron® Chip, Wide Temperature -40°C ~ +85°C
PWA-60WP2	60W, 24V/2.5A 100V AC to 240V AC Power Adapter for 2 Pin 3.5mm Terminal Block
WiFi Module	Mini PCIe WiFi Module with Antenna
3G Module	Mini PCIe 3G Module with Antenna
4G Module	Mini PCIe 4G Module with Antenna
DIN-Rail	DIN-Rail Kit

# Table of Contents

<b>CHAPTER1</b>	<b>GENERAL INTRODUCTION</b>	<b>8</b>
1.1	Overview	8
1.2	Product Specification	9
1.2.1	Specifications of Vecow SPC-2845	9
1.2.2	Specifications of Vecow SPC-2145	10
1.3	Supported CPU List	11
1.4	Mechanical Dimension	12
<b>CHAPTER2</b>	<b>GETTING TO KNOW YOUR SPC-2000</b>	<b>14</b>
2.1	Packing List	14
2.2	Front Panel I/O Functions	14
2.3	Power Button	15
2.4	Reset Tact Switch	16
2.5	PWR, WDT, HDD LED Indicator	16
2.6	DVI-I Connector	17
2.7	Isolated DIO Connector	18
2.8	Dual PoE LAN Connector	20
2.9	USB 3.0	22
2.10	DC-in 6V to 36V Terminal Block	22
2.11	Remote Power On/Off Switch	23
2.12	COM Serial Port	24
2.13	Audio Out Connector	25
2.14	Main Board Expansion Connectors	26
2.15	CN5 SATA II Connector	28
2.16	Mini PCIe Connector (CN8) with SIM Card Slot (CN7)	29
2.17	Main Board Jumper Settings	31
2.18	JP2(A) CMOS Clear Jumper Setting	32

<b>2.19</b>	<b>JP1 PCIe Mode Jumper Setting</b>	<b>33</b>
<b>2.20</b>	<b>CN15 Internal USB Connector</b>	<b>34</b>
<b>CHAPTER3 SYSTEM SETUP</b>		<b>35</b>
<b>3.1</b>	<b>How to Open Your SPC-2000 Chassis</b>	<b>35</b>
<b>3.2</b>	<b>Installing DDR3L SODIMM Modules</b>	<b>39</b>
<b>3.3</b>	<b>Installing SSD/HDD</b>	<b>41</b>
<b>3.4</b>	<b>Installing MiniPCIe Module</b>	<b>43</b>
<b>3.5</b>	<b>Mount Your SPC-2000</b>	<b>45</b>
<b>CHAPTER4 BIOS AND DRIVER</b>		<b>46</b>
<b>4.1</b>	<b>BIOS Settings</b>	<b>46</b>
<b>4.2</b>	<b>Main Menu</b>	<b>46</b>
<b>4.3</b>	<b>Advanced Function</b>	<b>47</b>
4.3.1	ACPI Setting	47
4.3.2	Serial Port 1 Configuration	48
4.3.3	Serial Port 2 Configuration	49
4.3.4	Serial Port 3 Configuration	50
4.3.5	Serial Port 4 Configuration	51
4.3.6	PPM Configuration	52
4.3.7	CPU Configuration	52
4.3.8	IDE Configuration	53
<b>4.4</b>	<b>Chipset Function</b>	<b>54</b>
4.4.1	Display Configuration	54
4.4.2	Power Loss Configuration	54
<b>4.5</b>	<b>Boot Function</b>	<b>56</b>
4.5.1	Change Boot Configuration	56
<b>4.6</b>	<b>Save &amp; Exit</b>	<b>56</b>
4.6.1	Reload Default BIOS Value	56
<b>APPENDIX A: ISOLATED DIO GUIDE</b>		<b>58</b>
<b>APPENDIX B: WDT FUNCTION</b>		<b>59</b>
<b>APPENDIX C: WIN7 INSTALLATION GUIDE</b>		<b>60</b>

# CHAPTER 1 GENERAL INTRODUCTION

## 1.1 Overview

With 3.5" form factor, SPC-2000 series is based on Quad Core Intel® Atom™ E3845 (formerly codenamed Bay Trail) processor family (1.91GHz) and DDR3L single channel 8GB ram, one DVI-I, four RS-232/422/485, isolated DIO, two PoE+ GbE LAN, one 2.5" SATA 3Gbps SSD/HDD tray, four USB 3.0 ports, and 2 miniPCIe. SPC-2000 series is in fanless mini form factor and capable of operating under wide temperatures from -25°C to +70°C for harsh environments. Design with four COM to satisfy various applications' control and connection requirements, SPC-2000 series still keep fanless and wide operation temperature plus with EN50155 standard and cable-less arrangement for industrial harsh environment. SPC-2000 series is ideal for information display in space-consuming and harsh environment, automation networking communication, IOT (Internet of Things), In-Vehicle Infotainment (IVI) systems, and M2M (Machine to Machine) applications.



## 1.2 Product Specification

### 1.2.1 Specifications of Vecow SPC-2845

System	
Processor	Quad Core Intel® Atom™ E3845 1.91GHz Processor (Bay Trail)
Chipset	Intel® Valleyview SoC
Memory	1 DDR3L 1333 SO-DIMM, up to 8GB
Video	1 DVI-I for VGA/DVI/HDMI Video Output
Audio	1 Speaker-out
Software Support	Windows 8, Windows 7, WES7, Linux
I/O Interface	
Serial	4 RS-232/422/485
LAN	2 Gigabit LAN by Intel® I210
PoE	2 Gigabit IEEE 802.3at (25.5W/48V) PoE+ Port
USB	4 USB 3.0
DIO	8 Isolated DIO : 4 DI, 4 DO
LED	Power/HDD/WTD/PoE
Mini PCIe	1 Mini PCIe Socket (PCIe/ USB/ SIM Card Socket) 1 Mini PCIe Socket (PCIe/ USB) optional with mSATA (Jumper Select)
Power Supply	
Power Input	Terminal Block; DC-in 6V to 36V, 2-pin Remote Power On/Off Switch
Power Output	Onboard 12V
Adaptor	AC to DC, 60W (Optional)
Storage	
SATA HDD	1 SATA II (3Gbps) 1 Front-access Removable HDD/SSD Tray (Optional)
mSATA	1 Mini PCIe Socket (PCIe + USB), optional with mSATA
Other	
Watchdog Timer	Reset: 1 to 255 sec./min. Per Step
Mechanical	
Dimension (W x L x H)	106mm x 150.4mm x 65.9mm (4.2" x 5.9" x 2.6")
Weight	1.4 kg (3.1 lb)
Mounting	DIN-Rail Mounting Kit (Optional) / Wallmount by mounting bracket
Design	Ultra-compact; 3.5" Form Factor Top cover Heat Sink; Fanless Design
Environment	
Operating Temperature	-25°C to 70°C (-13°F to 158°F)
Storage Temperature	-40°C to 85°C (-40°F to 185°F)
Humidity	10% to 95% Humidity, Non-condensing
Shock	IEC 60068-2-27 CFast: 50G @ Wallmount, Half sine, 11ms HDD: 20G @ Wallmount, Half sine, 11ms
Vibration	IEC 60068-2-64 (Random 1 Oct./min. 1hr/axis.) HDD: 1 Grms @ 5Hz to 500Hz
EMC	CE, FCC, EN50155, EN50121-3-2

### 1.2.2 Specifications of Vecow SPC-2145

<b>System</b>	
Processor	Quad Core Intel® Atom™ E3845 1.91GHz Processor (Bay Trail)
Chipset	Intel® Valleyview SoC
Memory	1 DDR3L 1333 SO-DIMM, up to 8GB
Video	1 DVI-I for VGA/DVI/HDMI Video Output
Audio	1 Speaker-out
Software Support	Windows 8, Windows 7, WES7, Linux
<b>I/O Interface</b>	
Serial	4 RS-232/422/485
LAN	2 Gigabit LAN Intel® I210
USB	4 USB 3.0
LED	Power/HDD/WTD/PoE
Mini PCIe	1 Mini PCIe Socket (PCIe/ USB/ SIM Card Socket) 1 Mini PCIe Socket (PCIe/ USB) optional with mSATA (Jumper Select)
<b>Power Supply</b>	
Power Input	Terminal Block; DC-in 6V to 36V, 2-pin Remote Power On/Off Switch
Power Output	Onboard 12V
Adaptor	AC to DC, 60W (Optional)
<b>Storage</b>	
SATA HDD	1 SATA II (3Gbps) 1 Front-access Removable HDD/SSD Tray (Optional)
mSATA	1 Mini PCIe Socket (PCIe + USB), optional with mSATA
<b>Other</b>	
Watchdog Timer	Reset: 1 to 255 sec./min. Per Step
<b>Mechanical</b>	
Dimension (W x L x H)	106mm x 150.4mm x 65.9mm (4.2" x 5.9" x 2.6")
Weight	1.4 kg (3.1 lb)
Mounting	DIN-Rail Mounting Kit (Optional) / Wallmount by mounting bracket
Design	Ultra-compact; 3.5" Form Factor Top cover Heat Sink; Fanless Design
<b>Environment</b>	
Operating Temperature	-25°C to 70°C (-13°F to 158°F)
Storage Temperature	-40°C to 85°C (-40°F to 185°F)
Humidity	10% to 95% Humidity, Non-condensing
Shock	IEC 60068-2-27 CFast: 50G @ Wallmount, Half sine, 11ms HDD: 20G @ Wallmount, Half sine, 11ms
Vibration	IEC 60068-2-64 (Random 1 Oct./min. 1hr/axis.) HDD: 1 Grms @ 5Hz to 500Hz
EMC	CE, FCC, EN50155, EN50121-3-2

### 1.3 Supported CPU List

Processor No.	Core Count	CPU Freq (GHz)	Gfx Freq (MHz) Nominal/Turbo	TDP
E3845	4C	1.91GHz	542/792	10W
E3827	2C	1.75GHz	542/792	8W
E3826	2C	1.46GHz	533/667	7W
E3825	2C	1.33 GHz	533 (No Turbo)	6W
E3815	1C	1.46 GHz	400 (No Turbo)	5W

## 1.4 Mechanical Dimension

Figure1.1 SPC-2145

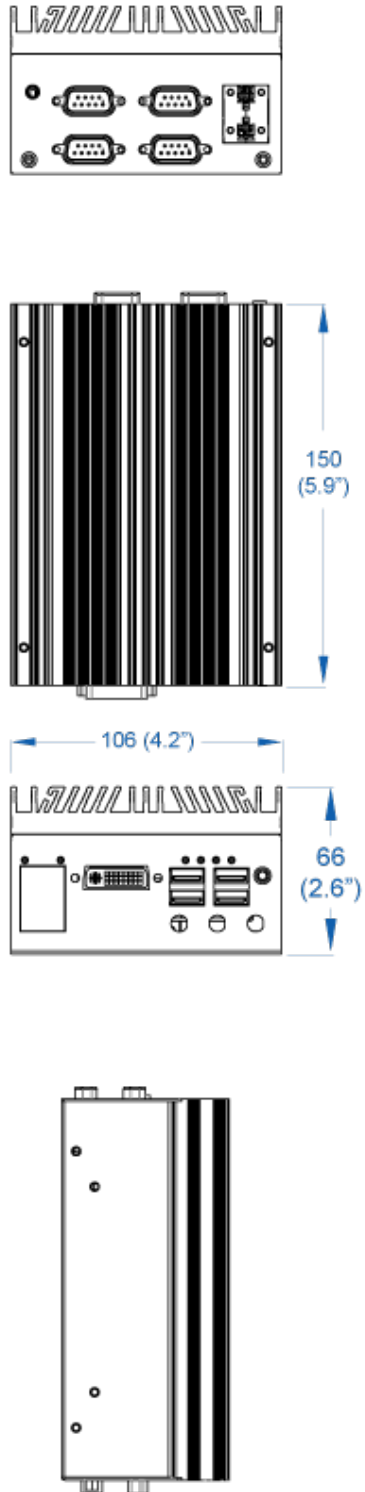
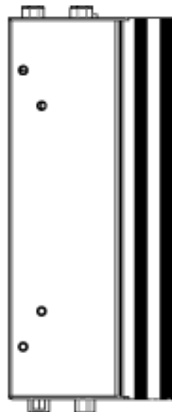
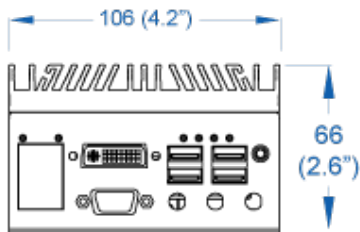
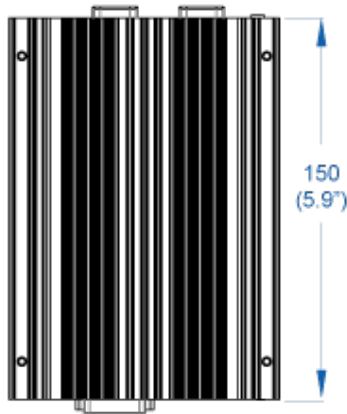
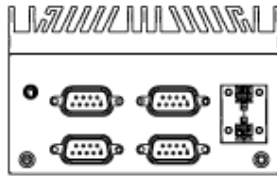

Figure1.2 SPC-2845



# CHAPTER 2 GETTING TO KNOW YOUR SPC-2000

## 2.1 Packing List

Item	Description	Qty.
1	SPC-2000 Ultra-compact Embedded System (According to the configuration you order, the SPC-2000 series may contain SSD/HDD and DDR3L SO-DIMM. Please verify these items if necessary.)	1
2	Accessory box, which contains <ul style="list-style-type: none"> <li>• Wall-mounting bracket</li> <li>• M4 screws for wall-mounting bracket</li> <li>• M3 screws for SSD Bracket and Wall-mount Bracket</li> <li>• 2-pin pluggable terminal block</li> </ul>	2 4 12 2

## 2.2 Front Panel I/O Functions

On SPC-2000 series, all I/O connectors are located on front panel and rear panel. Most general computer connectors (i.e. LAN, USB, DVI-I, DIO and etc.) are placed on the front panel.

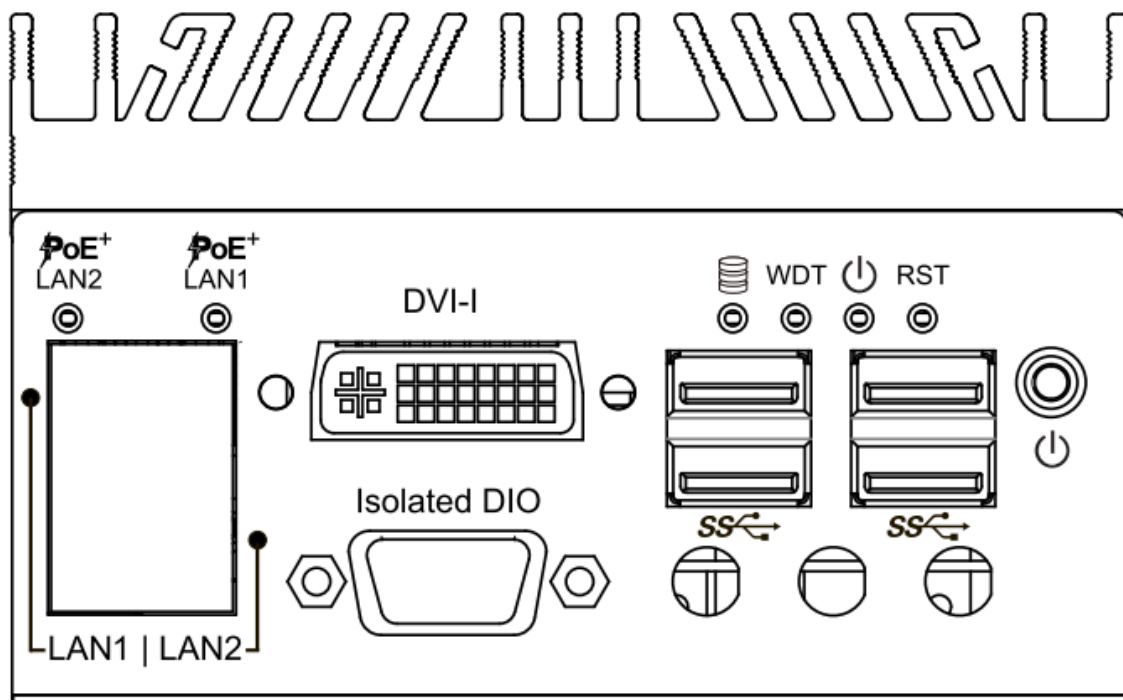

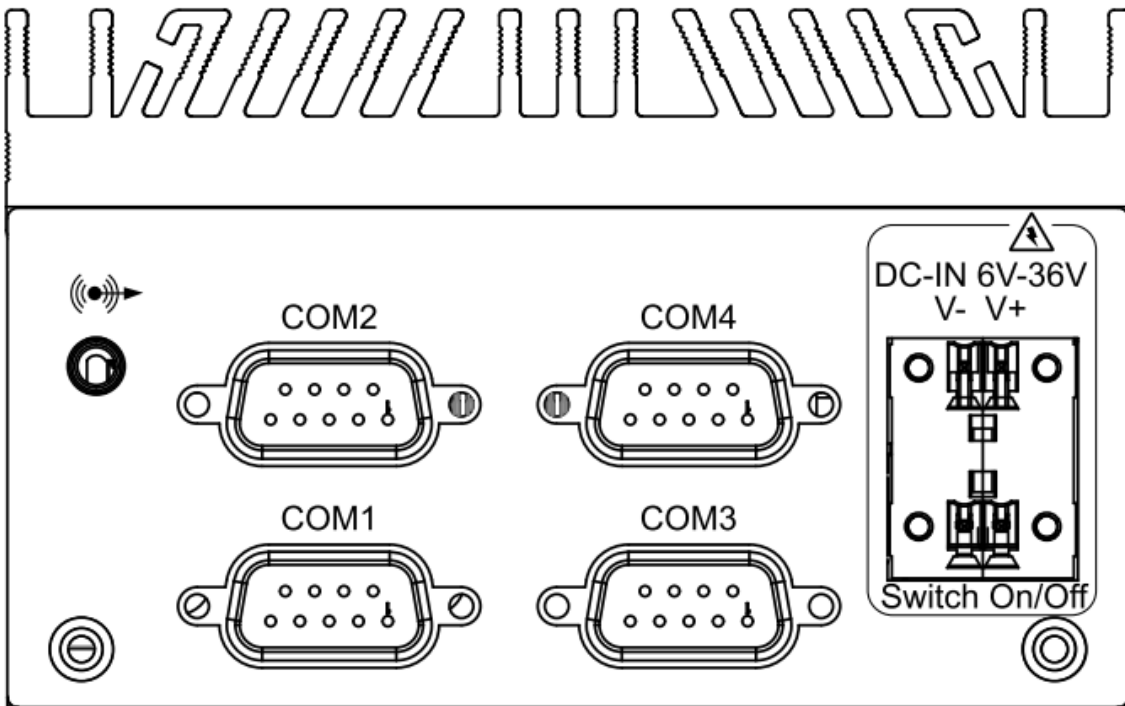

### 2.3 Power Button

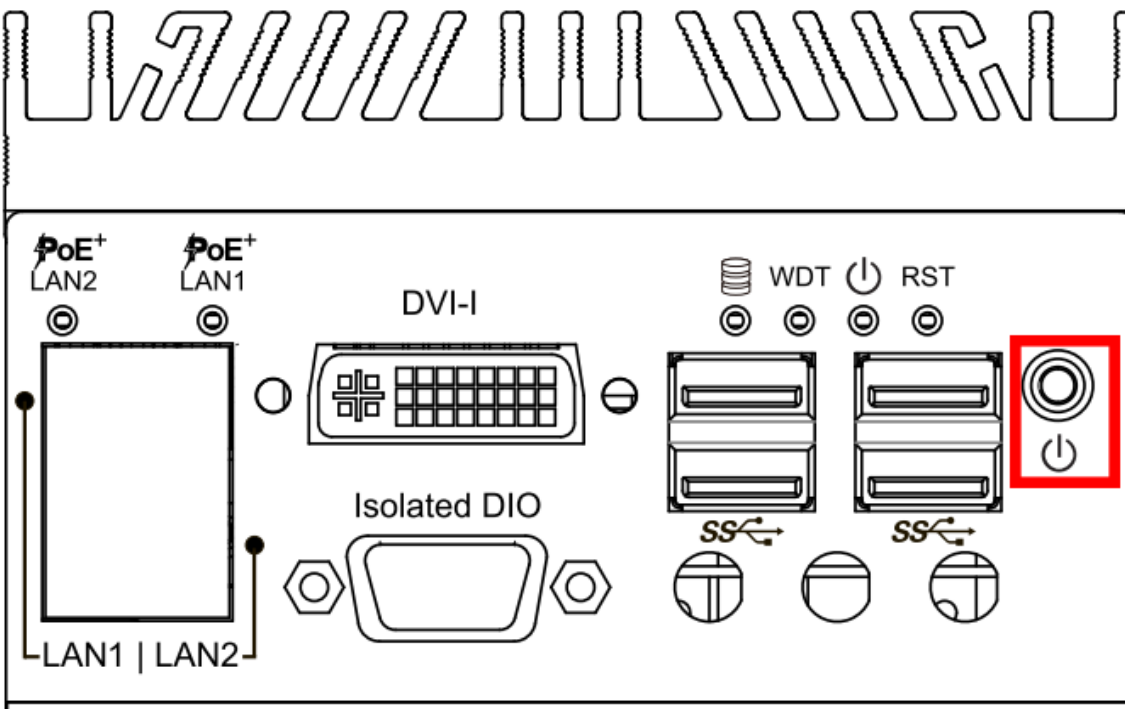

The power button is a non-latched switch. In case of system halts, you can press and hold the power button for 4 seconds to compulsorily shut down the system. Please note that a 4 seconds interval is kept by the system between two on/off operations (i.e. once turning off the system, you shall wait for 4 seconds to initiate another power-on operation).

## 2.4 Reset Tact Switch

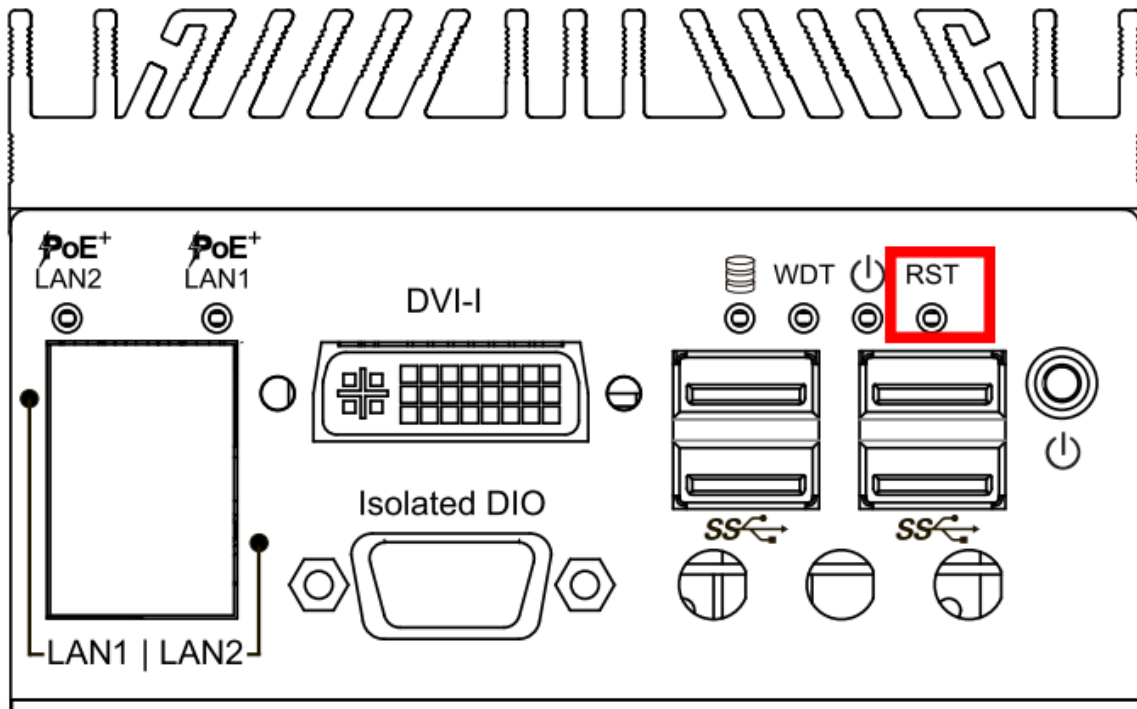

It is a hardware reset switch. Use this switch to reset the system without turning off the power. Momentarily pressing the switch will activate a reset.

## 2.5 PWR, WDT, HDD LED Indicator

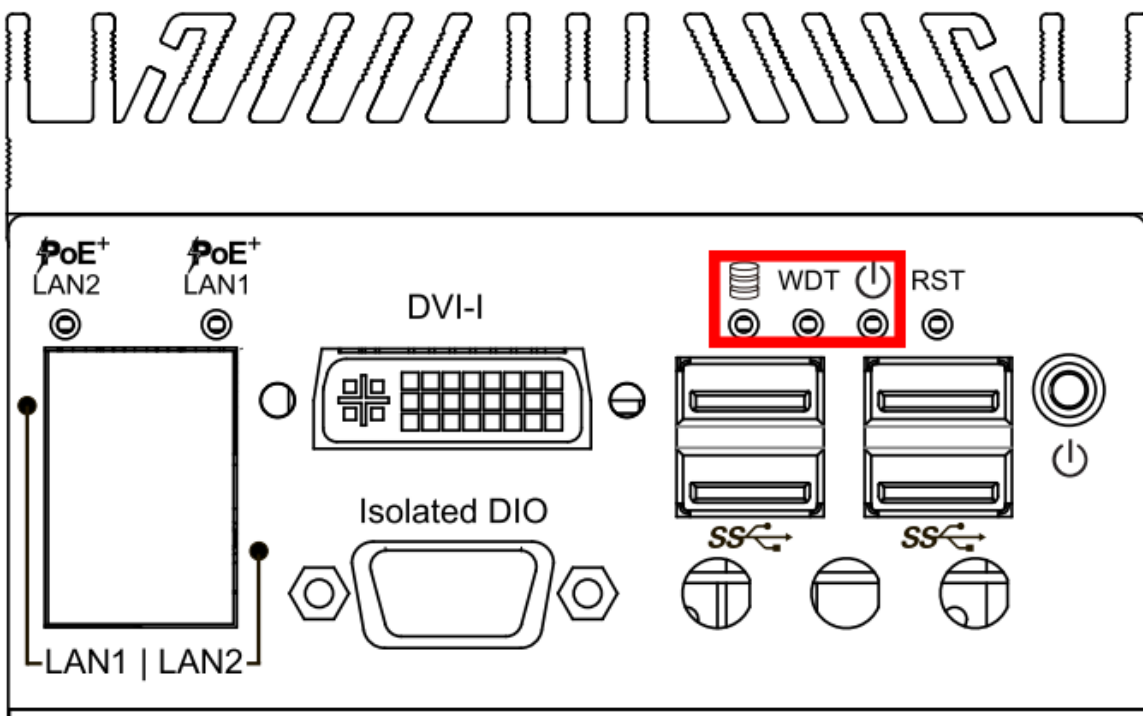



Green-Power LED: If the LED is solid green, it indicates that the system is powered on.

Green-WDT LED: Watch Dog LED.

Yellow -HDD LED: A hard disk LED. If the LED is on, it indicates that the system's storage is functional. If it is off, it indicates that the system's storage is not functional. If it is flashing, it indicates data access activities.

## 2.6 DVI-I Connector

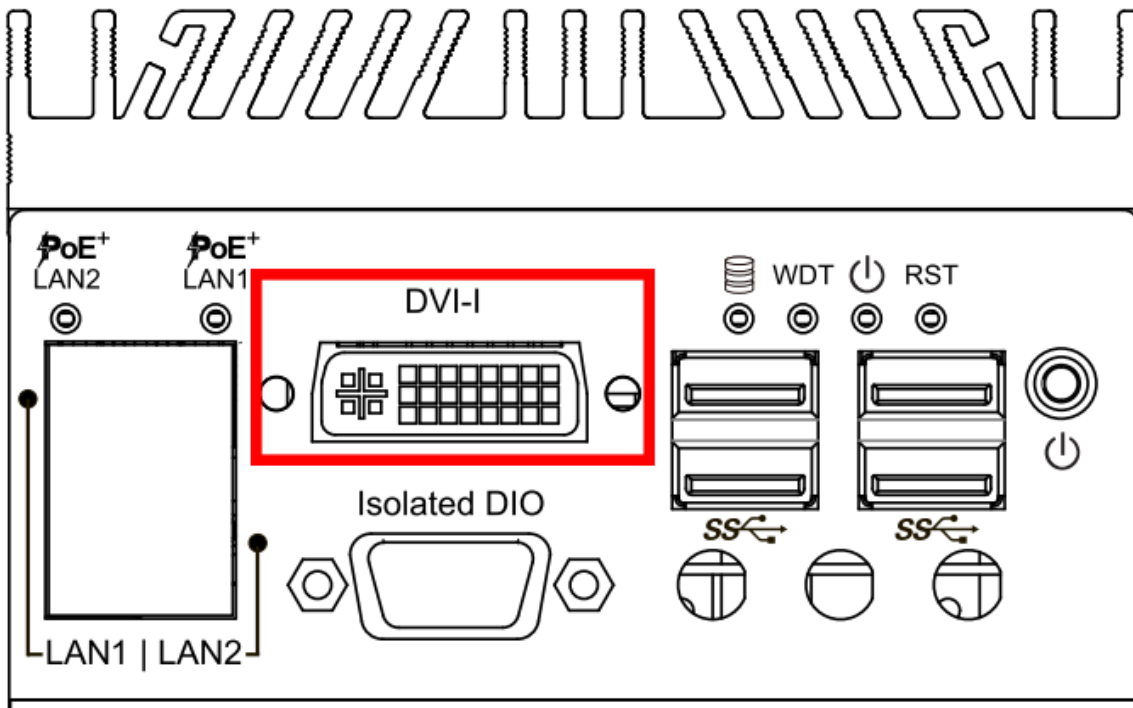

The DVI-I connector on the front panel supports both DVI and VGA operation mode. This connector can either output DVI signals or VGA signal. The DVI output mode supports up to 1920x1200 resolution and VGA output mode supports up to 2560x1600 resolution.

## 2.7 Isolated DIO Connector

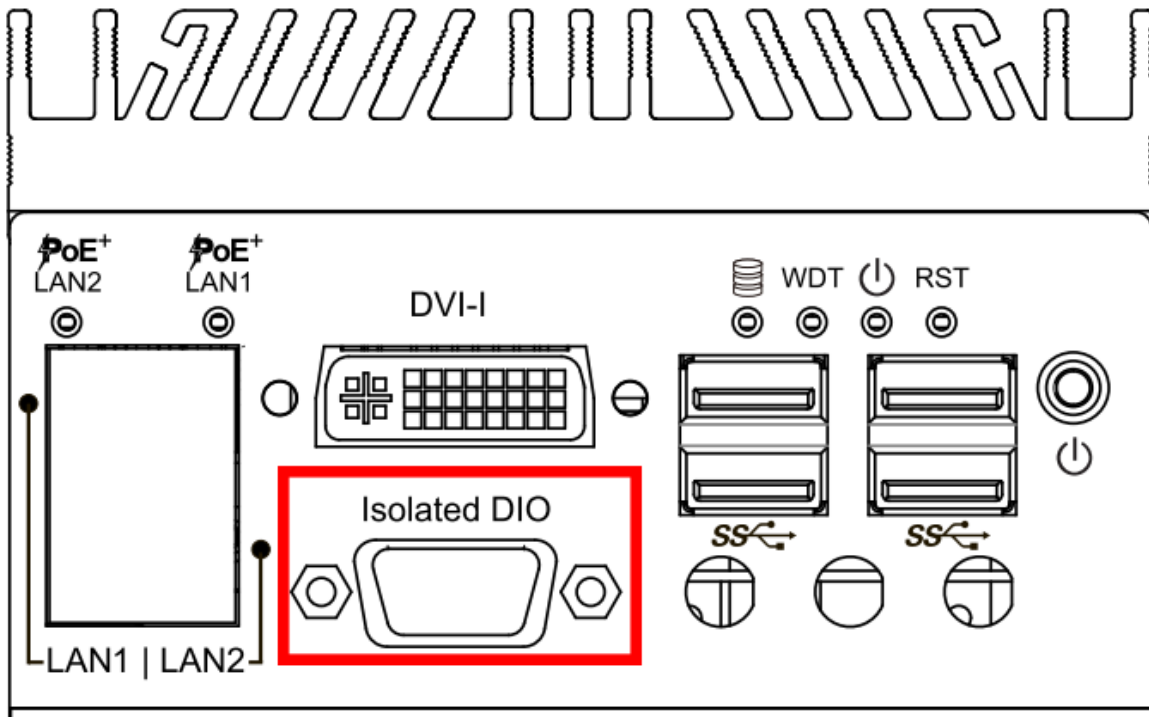

The SPC-2000 offers an 8-bit DIO (4-DI/ 4-DO) connector. Each bit of DI and DO is equipped with a photo-coupler for isolated protection. Because the DIO is isolated by photocouplers, it requires power supply from external to activate this feature.

Pin Number	Description	Mapping to SIO GPIO Function
1	OUTPUT0	SIO_GPO70
2	INPUT 0	SIO_GPO74
3	OUTPUT1	SIO_GPO71
4	INPUT 1	SIO_GPO75
5	OUTPUT2	SIO_GPO72
6	INPUT 2	SIO_GPO76
7	OUTPUT3	SIO_GPO73
8	INPUT 4	SIO_GPO77
9	GND_ISO	

## GPI Mode Internal Block Diagram

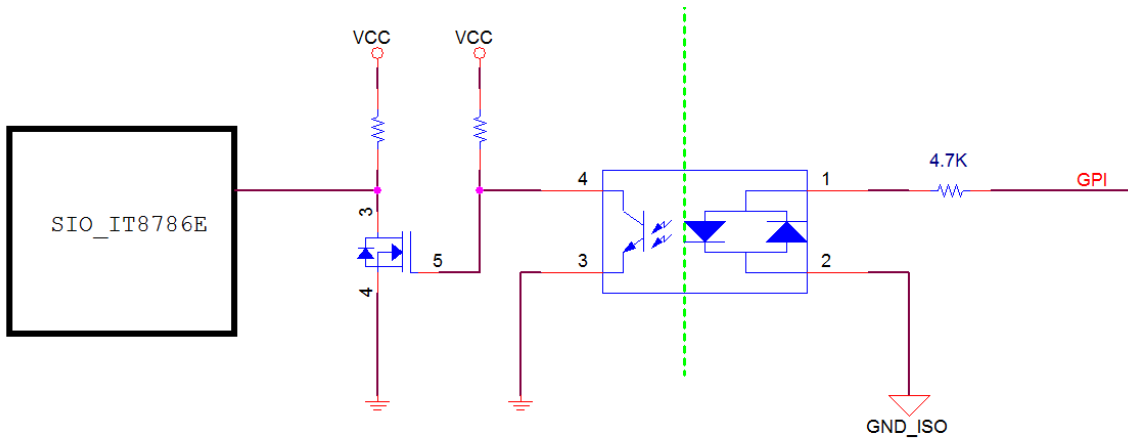

## Absolute Maximum Ratings

		Values		Unit
		MIN	MAX	
V <sub>IH</sub>	High-Level Input Voltage	5	40	V
V <sub>L</sub>	Low-Level Input Voltage	0	0.5	

## GPO Mode Internal Block Diagram

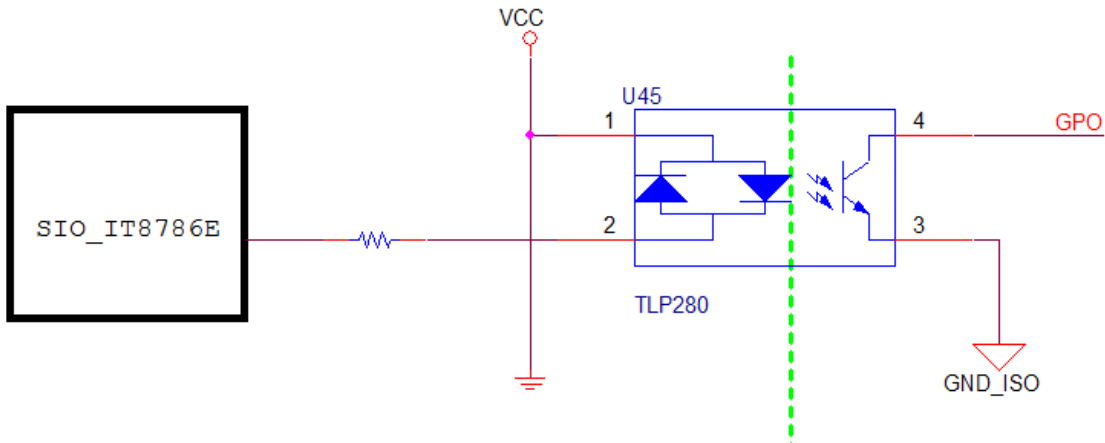

## Absolute Maximum Ratings

		Values		Unit
		MIN	MAX	
V <sub>DSS</sub>	Drain-source voltage		40	V
I <sub>D</sub>	Output current		30	mA

## 2.8 Dual PoE LAN Connector

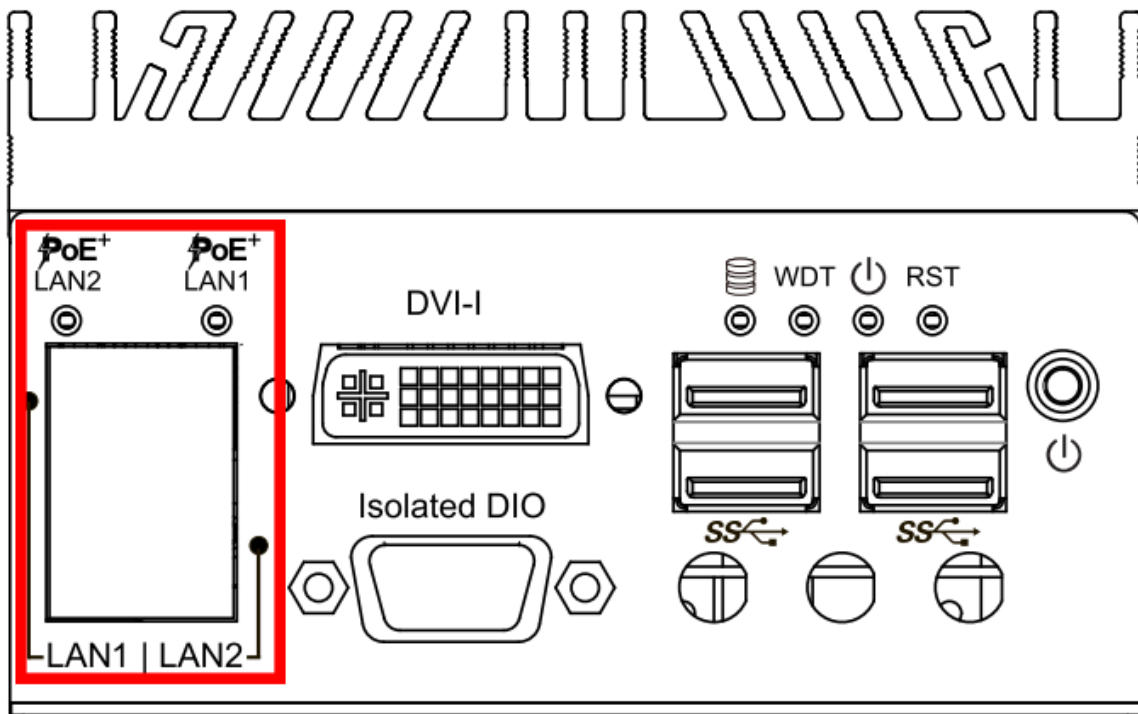

The 10/100/1000 Mbps Ethernet LAN ports 1 and 2 use 8-pin RJ-45 connector. LAN 1 and LAN 2 are equipped with Intel I210 LAN chip. Using suitable RJ-45 cable, you can connect SPC-2000 system to a computer, or to any other piece of equipment that has an Ethernet connection, for example, a hub or a switch. Moreover, both of them have Wake-on-LAN and Preboot Execution Environment capabilities. The following diagram shows the pinouts for LAN 1 and LAN 2 port.

Pin Number	10 / 100 Mbps	1000 Mbps
1	E_TX+	MDIO_P
2	E_TX-	MDIO_N
3	E_RX+	MDI1_P
4	----	MDI2_P
5	-----	MDI2_N
6	E_RX-	MDI1_N
7	-----	MDI3_P
8	-----	MDI3_N

The Ethernet ports use standard RJ-45 jack connectors with LED indicators on the front side to show Active/Link status and Speed status.

The LED indicators on the right bottom corners glow a solid green color when the cable is properly connected to a 100 Mbps Ethernet network. The LED indicator on the left bottom corner will flash on and off when Ethernet packets are being transmitted or received.

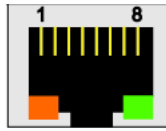

	10 Mbps	100 Mbps	1000 Mbps
Right bottom LED	Off	Solid Green	Solid Orange
Left bottom LED	Flash Yellow	Flash Yellow	Flash Yellow
Right bottom LED	Off	Solid Green	Solid Orange

SPC-2000 has a PSE controller designed for use in IEEE 802.3 Type 1 and Type 2 (highpower) compliant Power over Ethernet systems. If insert PD device, then PoE LED indicator is on

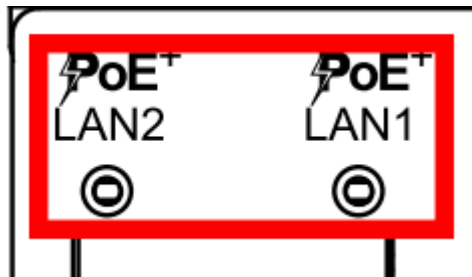

## 2.9 USB 3.0

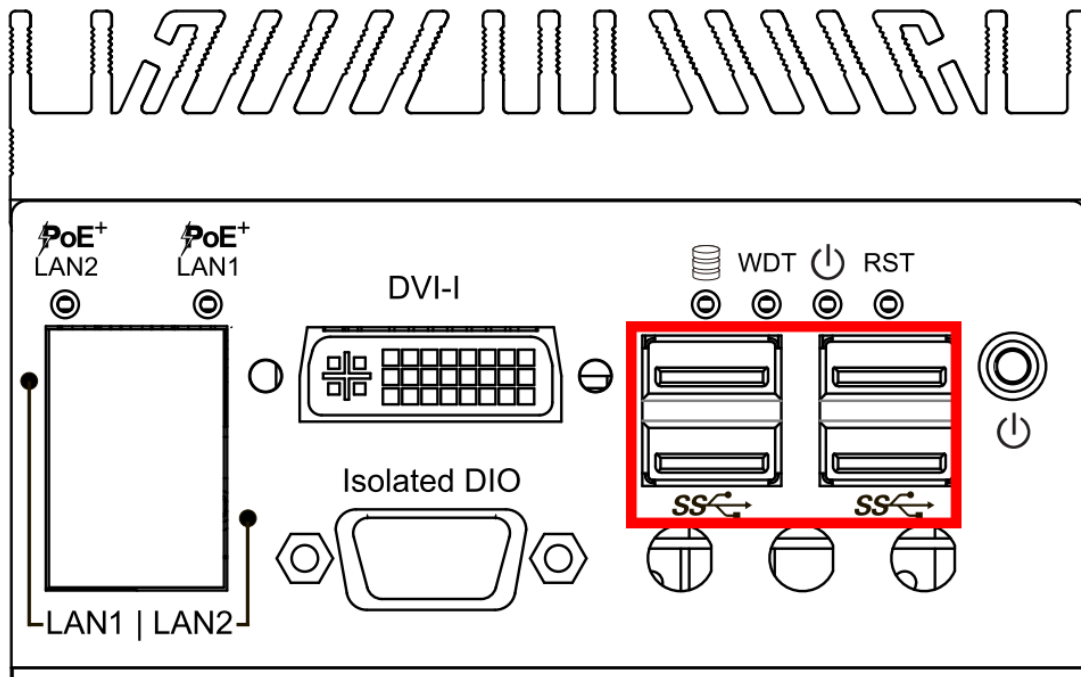

The SPC-2000 comes with 4 USB 3.0 hosts on the front panel. These USB 3.0 ports allow data transfers up to 5 Gbps. The controller supports Super-Speed (SS), High-Speed (HS), Full-Speed (FS) and Low-Speed(LS) traffic on the bus.

## 2.10 DC-in 6V to 36V Terminal Block

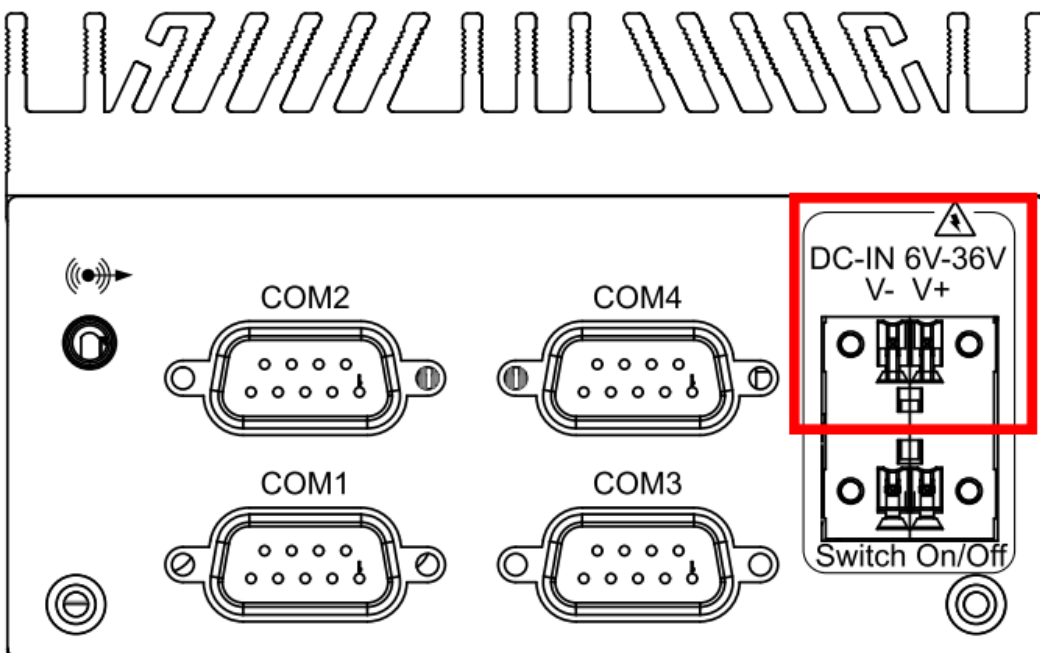

The SPC-2000 offers 6 to 36 VDC power input with the terminal block.

## 2.11 Remote Power On/Off Switch

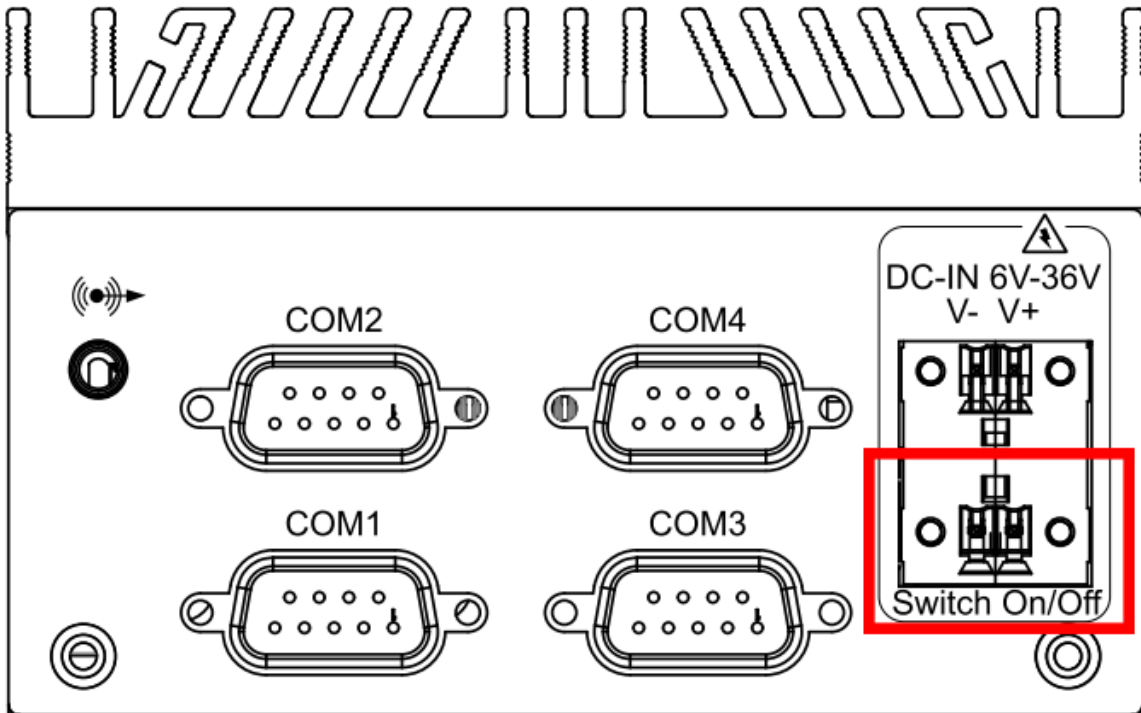

It is a 2-pin power-on or power-off switch through Phoenix Contact terminal block. You could turn on or off the system power by using this contact. This terminal block support dual function of soft power-on / power-off (instant off or delay 4 second), and suspend mode.

## 2.12 COM Serial Port

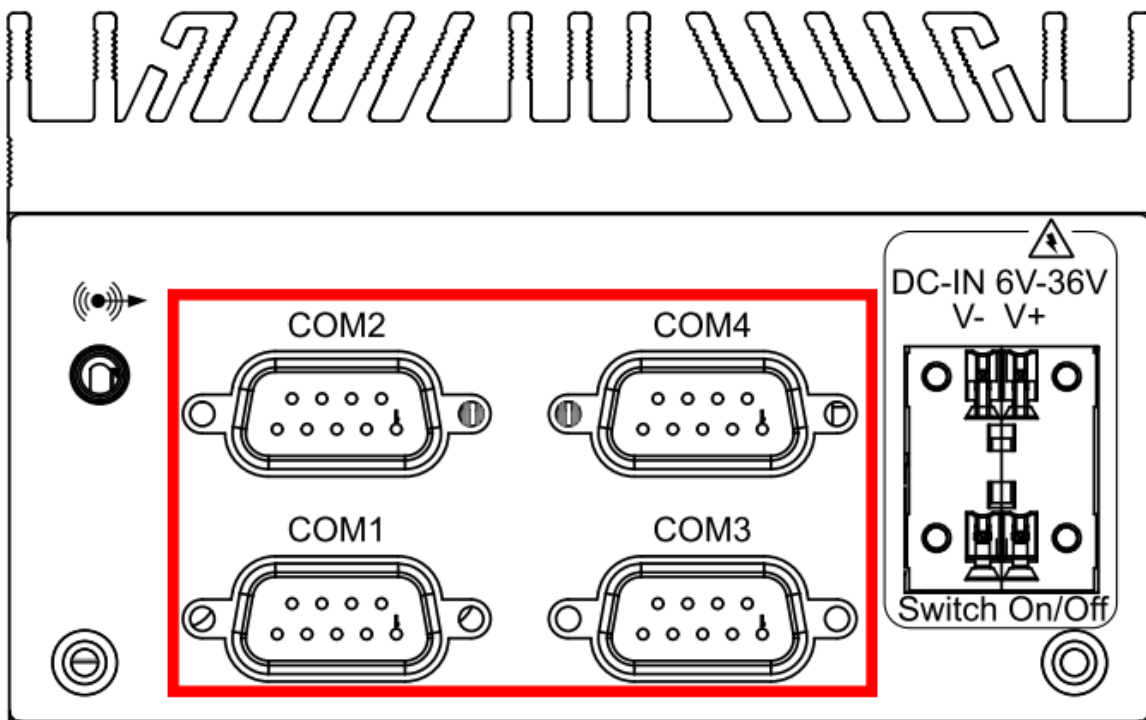

All serial COM can be configured for RS-232, RS-422, or RS-485 with auto flow control communication. Serial Port 2 default setting is RS-232, if you want to use RS-422 or RS-485, you can find the setting in BIOS.

BIOS Setting	Function
COM1~COM4	RS-232
	RS-422 (5-wire)
	RS-422 (9-wire)
	RS-485
	RS-485 w/z auto-flow control



The pin assignments are shown in the following table:

Serial Port	Pin Number	RS-232	RS-422 (5-wire)	RS-422 (9-wire)	RS-485 (3-wire)
1~4	1	DCD	TXD-	TXD-	DATA-
	2	RXD	TXD+	TXD+	DATA+
	3	TXD	RXD+	RXD+	-----
	4	DTR	RXD-	RXD-	-----
	5	GND	GND	GND	GND
	6	DSR	-----	RTS-	-----
	7	RTS	-----	RTS+	-----
	8	CTS	-----	CTS+	-----
	9	RI	-----	CTS-	-----

## 2.13 Audio Out Connector

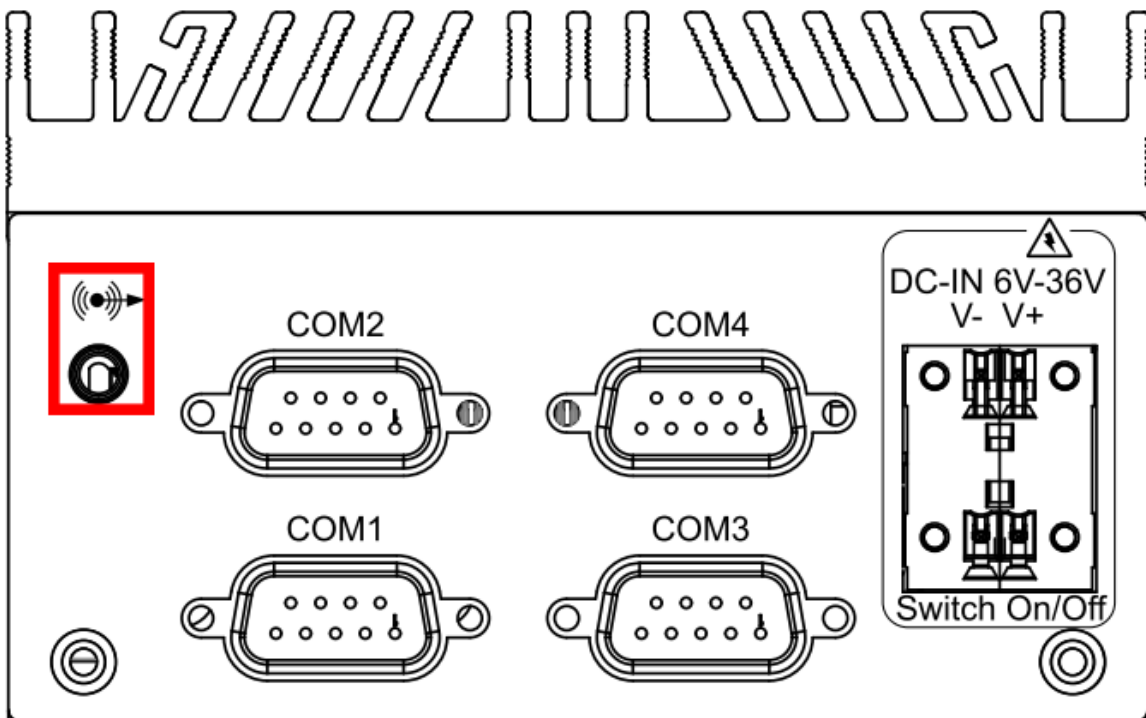

The SPC-2000 offers stereo audio connector of Line-Out. The audio chip controller is by ALC888S-VD which is compliant with the Intel Azalia standard. To utilize the audio function in Windows, you need to install corresponding drivers for Realtek ALC888S-VD codec.

## 2.14 Main Board Expansion Connectors

The figure below is the top view of the SPC-2000 main board which is the main board used in the SPC-2000 Series system. It shows the location of the connectors.

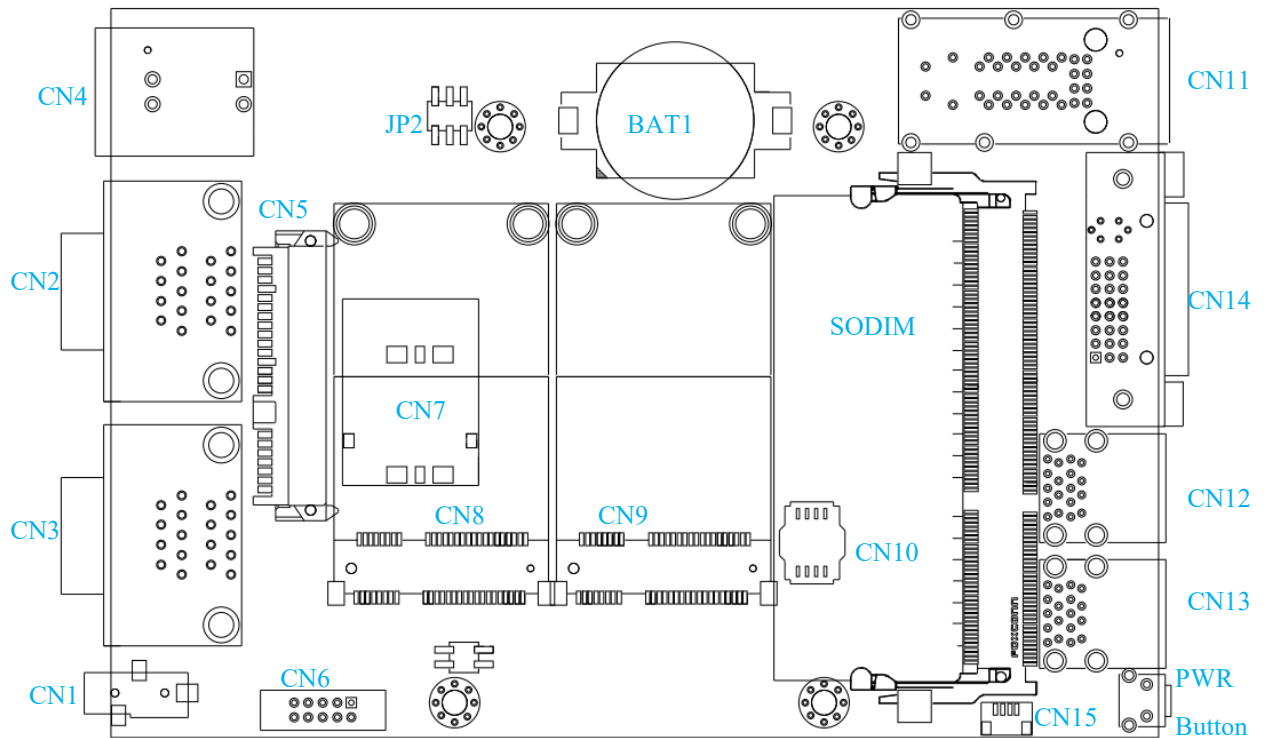

The figure below is the bottom view of the SPC-2000 main board.

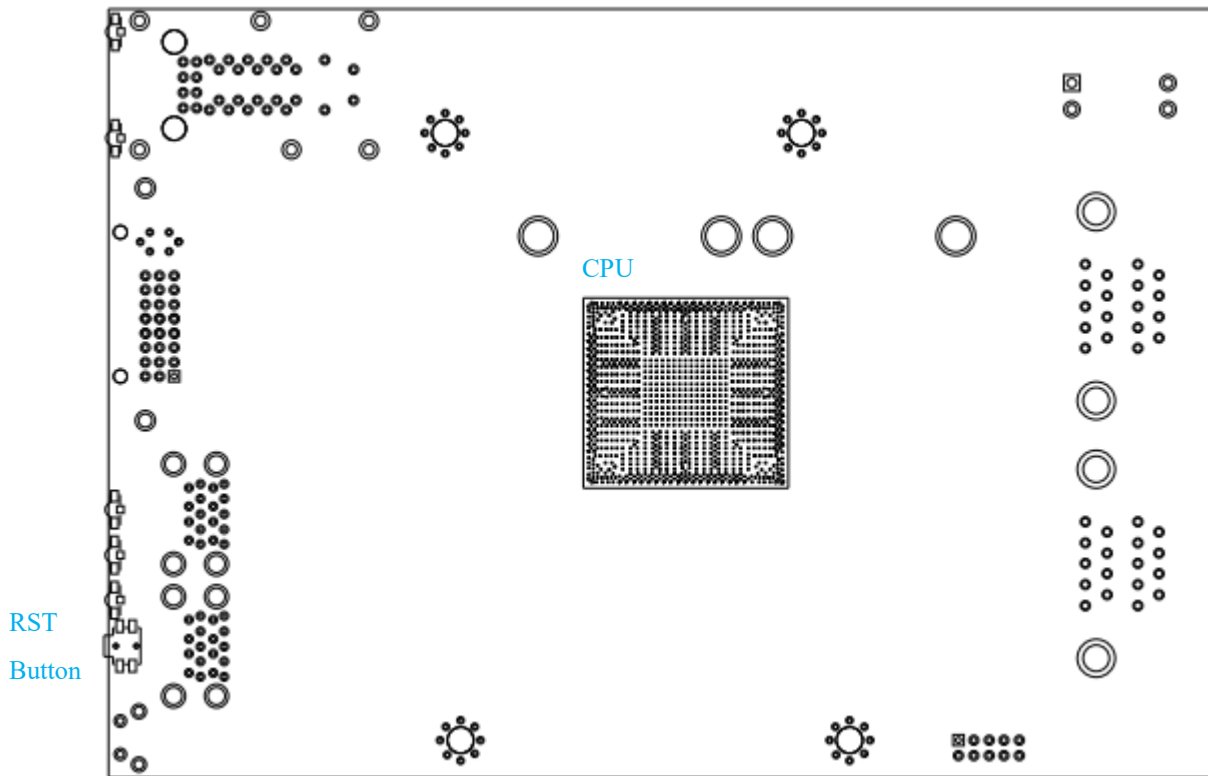

## 2.15 CN5 SATA II Connector

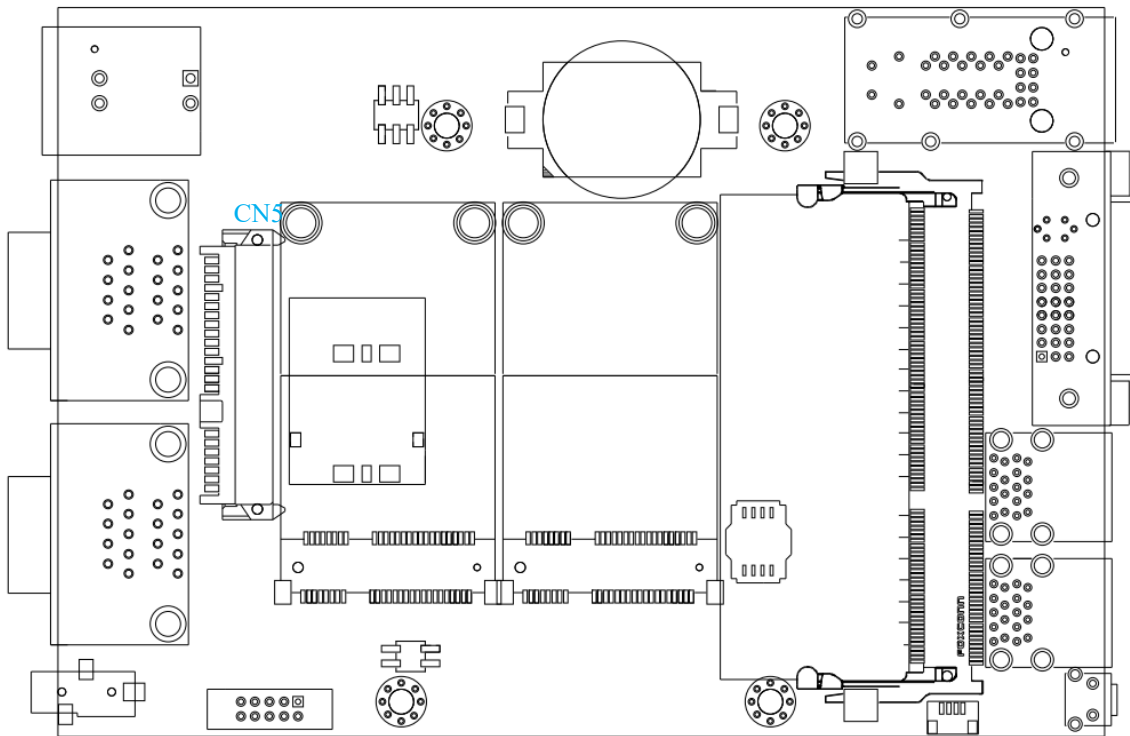

The SPC-2000 features high performance Serial ATA II interfaces that eases cabling to hard drives or SSD with thin and short cables while application need larger storage capacity.

Pin Number	Definition	Pin Number	Definition
1	GND	12	GND
2	TXP	13	GND
3	TXN	14	5V
4	GND	15	5V
5	RXN	16	5V
6	RXP	17	GND
7	GND	18	GND
8	NC	19	GND
9	NC	20	12V
10	NC	21	12V
11	GND	22	12V

## 2.16 Mini PCIe Connector (CN8) with SIM Card Slot (CN7)

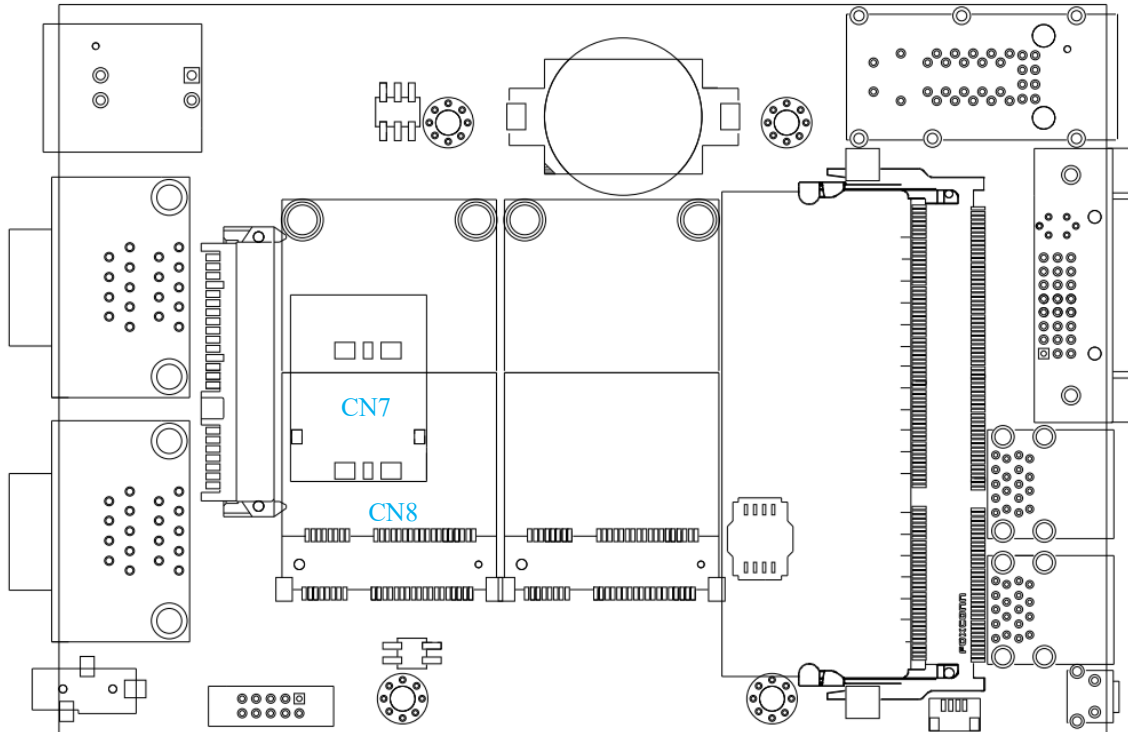

**CN8 Mini PCIe Connector Pin Out**

Pin #	Signal Name	Pin #	Signal Name
51	NC	52	+3.3Vaux
49	NC	50	GND
47	NC	48	+1.5V
45	NC	46	NC
43	GND	44	NC
41	+3.3Vaux	42	NC
39	+3.3Vaux	40	GND
37	GND	38	USB_D+
35	GND	36	USB_D-
33	PETp0	34	GND
31	PETn0	32	SMB_DATA
29	GND	30	SMB_CLK
27	GND	28	+1.5V
25	PERp0	26	GND
23	PERn0	24	+3.3Vaux
21	GND	22	PERST#
19	NC	20	NC
17	NC	18	GND
Mechanical Key			
15	GND	16	UIM_VPP

13	REFCLK+	14	UIM_RST
11	REFCLK-	12	UIM_CLK
9	GND	10	UIM_DATA
7	CLKREQ#	8	UIM_PWR
5	NC	6	1.5V
3	NC	4	GND
1	WAKE#	2	3.3Vaux

## 2.17 Main Board Jumper Settings

The figure below is the top view of the SPC-2000 main board which is the main board used in the SPC-2000 Series system. It shows the location of the jumpers.

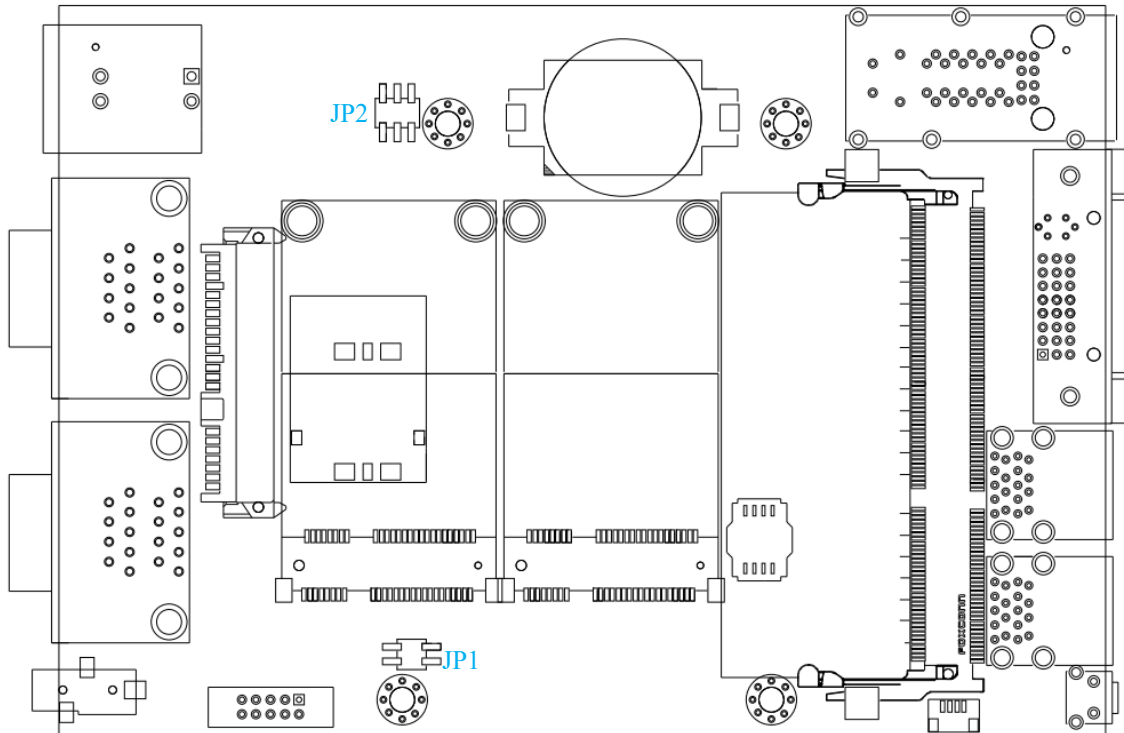

You may configure your card to match the needs of your application by setting jumpers. A jumper is a metal bridge used to close an electric circuit. It consists of two metal pins and a small metal clip (often protected by a plastic cover) that slides over the pins to connect them. To “close” a jumper, you connect the pins with the clip. To “open” a jumper, you remove the clip. Sometimes a jumper will have three pins, labeled 1, 2 and 3. In this case you would connect either pins 1 and 2, or 2 and 3.

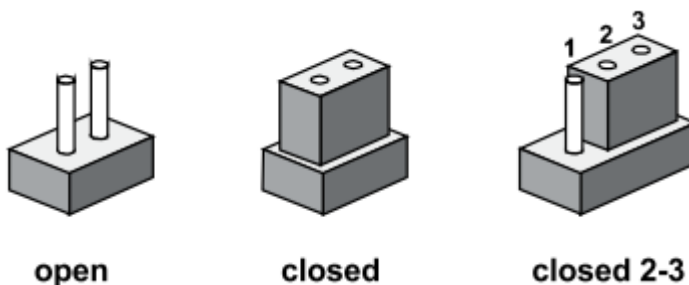

## 2.18 JP2(A) CMOS Clear Jumper Setting

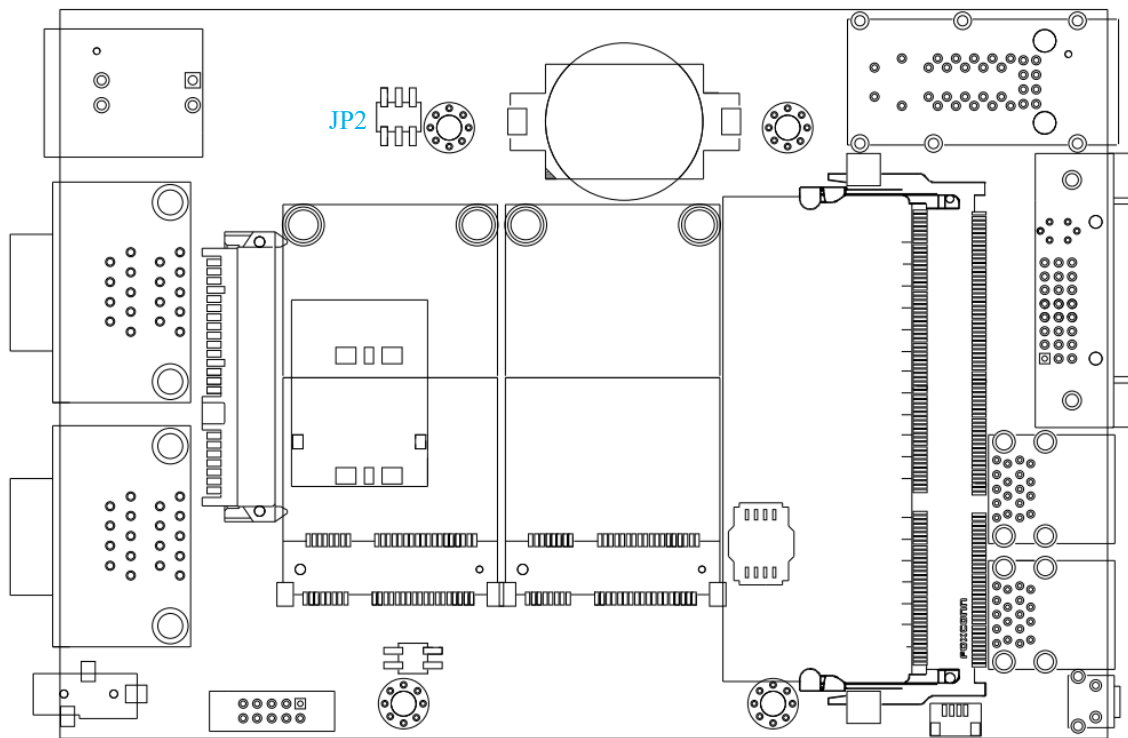

Setting	Description
1-3	Normal (Default)
3-5	Clear CMOS



## 2.19 JP1 PCIe Mode Jumper Setting

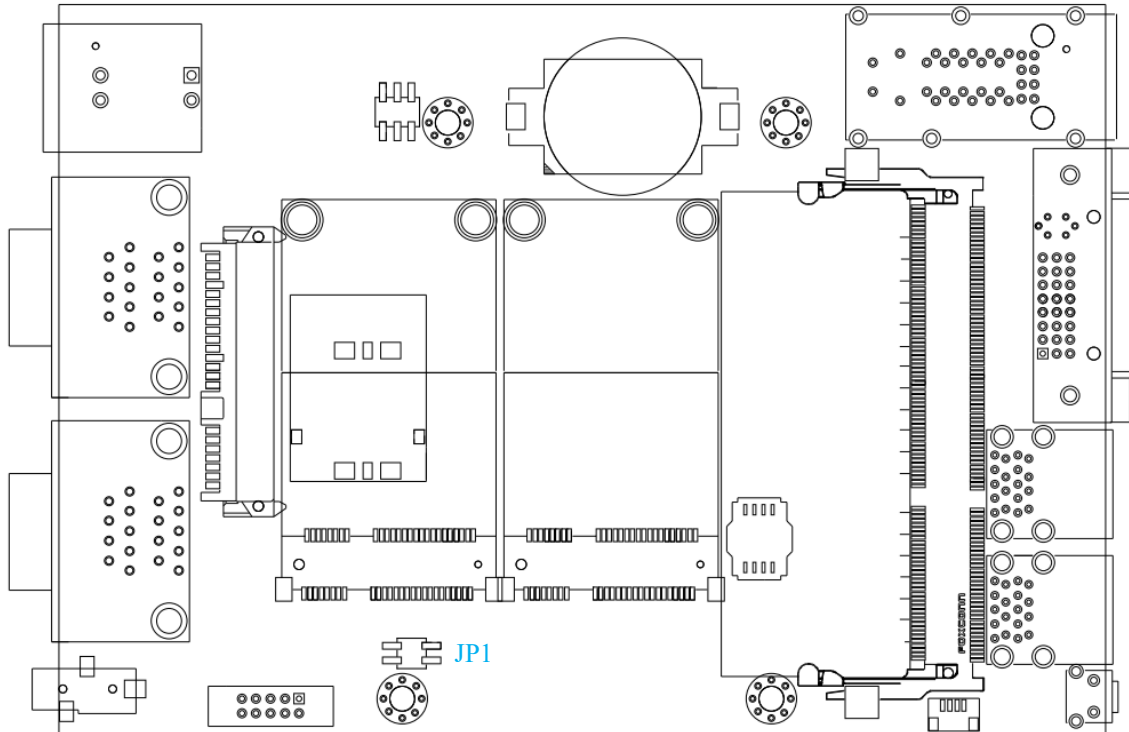

Setting	Description
1-2	Auto Detection (Default)
2-4	Mini PCIe
1-3	mSATA

## 2.20 CN15 Internal USB Connector

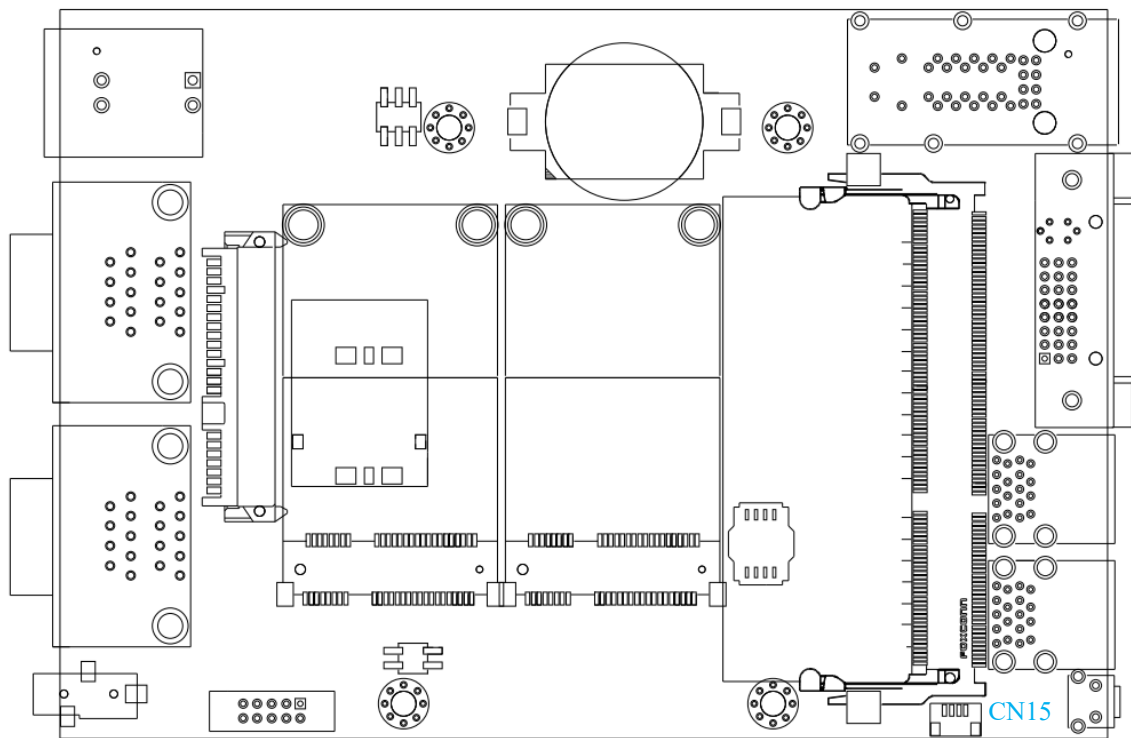

This internal USB connector type is JST-BM04B-SRSS-TB

Internal USB connector pinouts as below

Pin No.	Description
1	+3.3V
2	USB_N
3	USB_P
4	GND

# CHAPTER3 SYSTEM SETUP

## 3.1 How to Open Your SPC-2000 Chassis

1. Remove 4 pcs M3 PH screw from Heatsink top

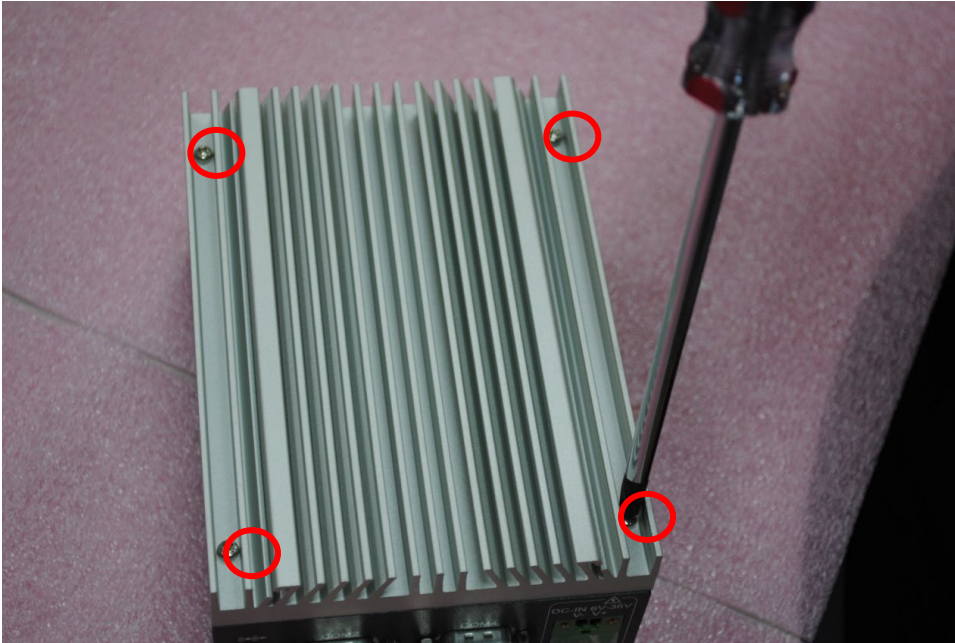

2. Remove 8 pcs #4-40 spacer from front panel

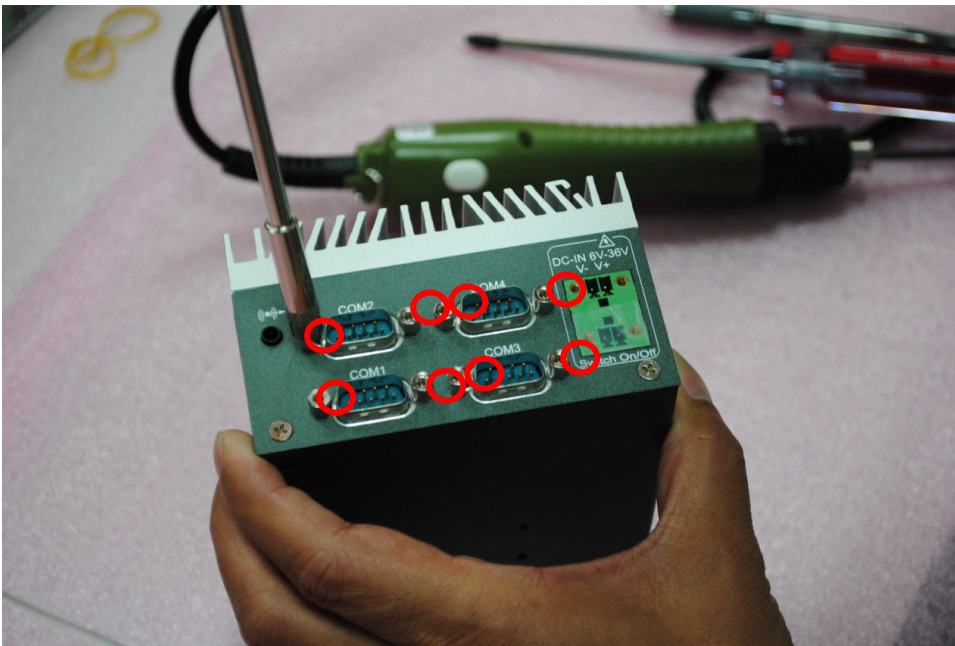

3. Remove 2 pcs M3 FH screw from front panel



4. Take off front panel away from SPC-2000



5. Remove 4 pcs #4-40 spacer from Rear panel



6. Pull Heatsink and Bottom case until you can see the fully GPIO socket

Caution: don't pull out heatsink and bottom case completely before removing GPIO cable from socket

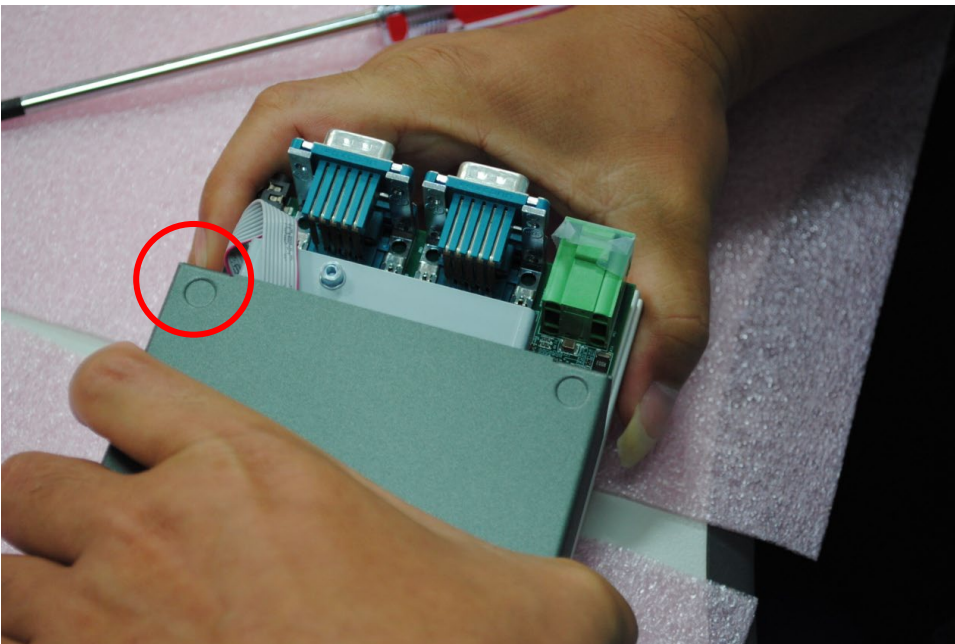

7. Remove GPIO cable from PCB socket

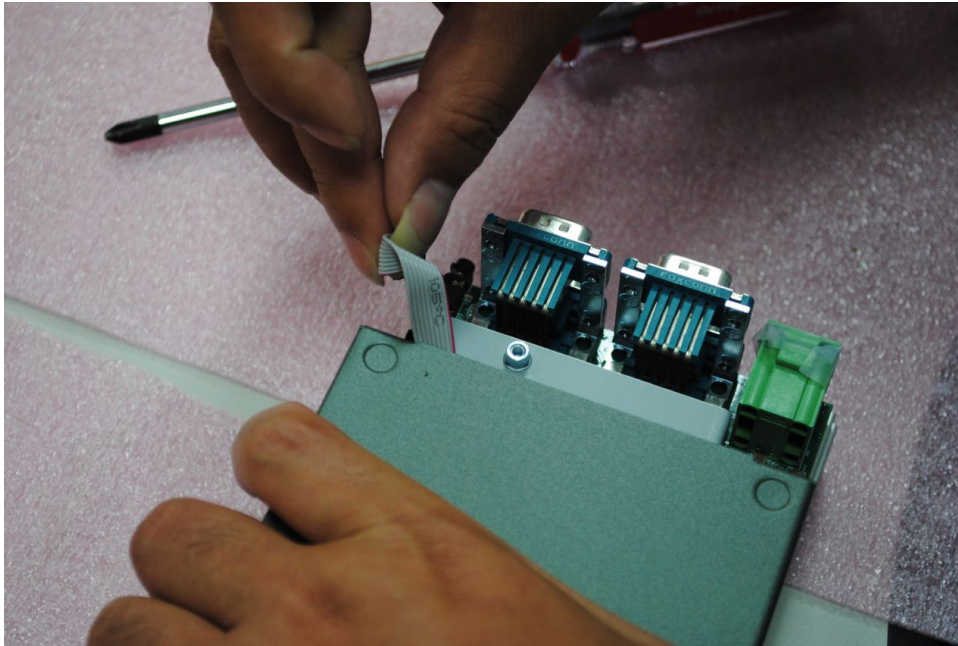

8. Separate Heatsink and Bottom case

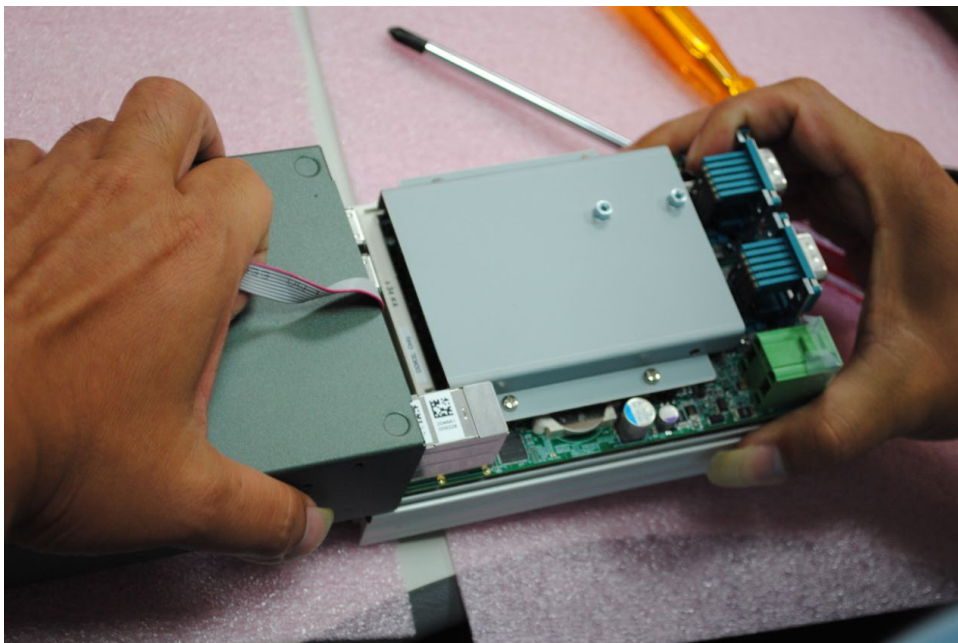

## 3.2 Installing DDR3L SODIMM Modules

1. Remove 4 pcs M3 PH screw from HDD bracket

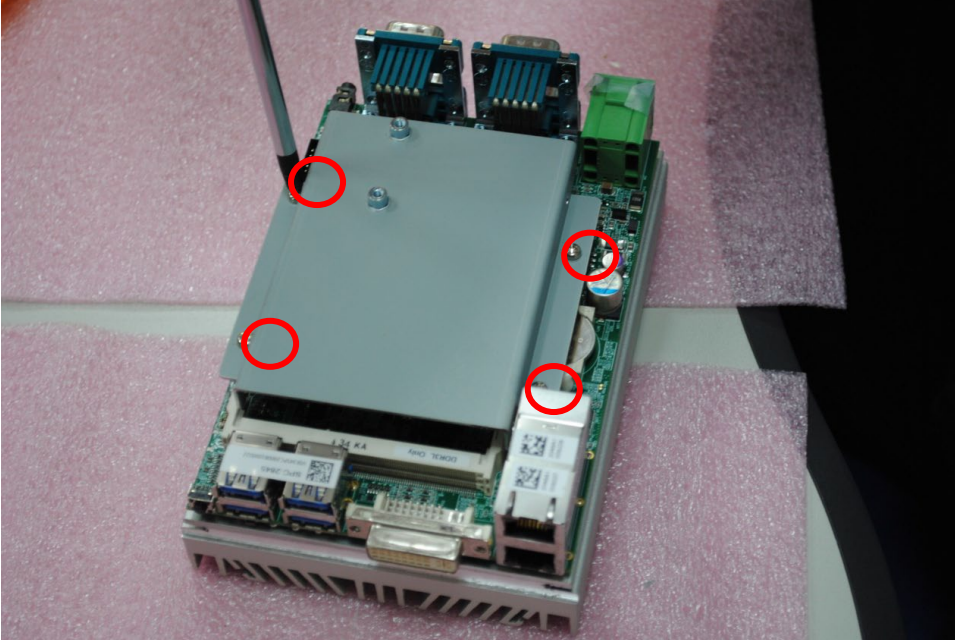

2. Install RAM module into RAM socket

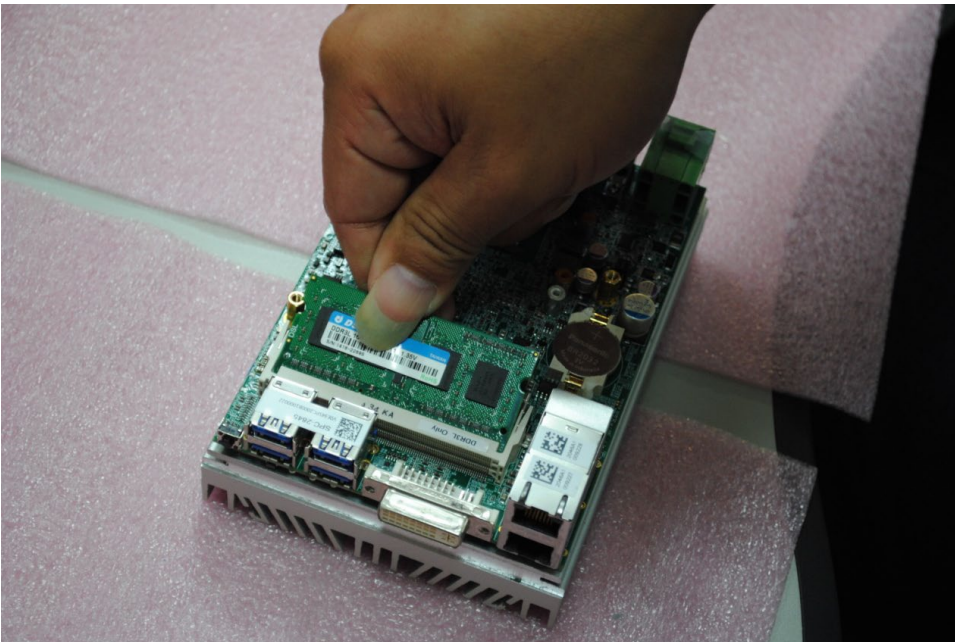

3. Make sure RAM socket and RAM module both side locked

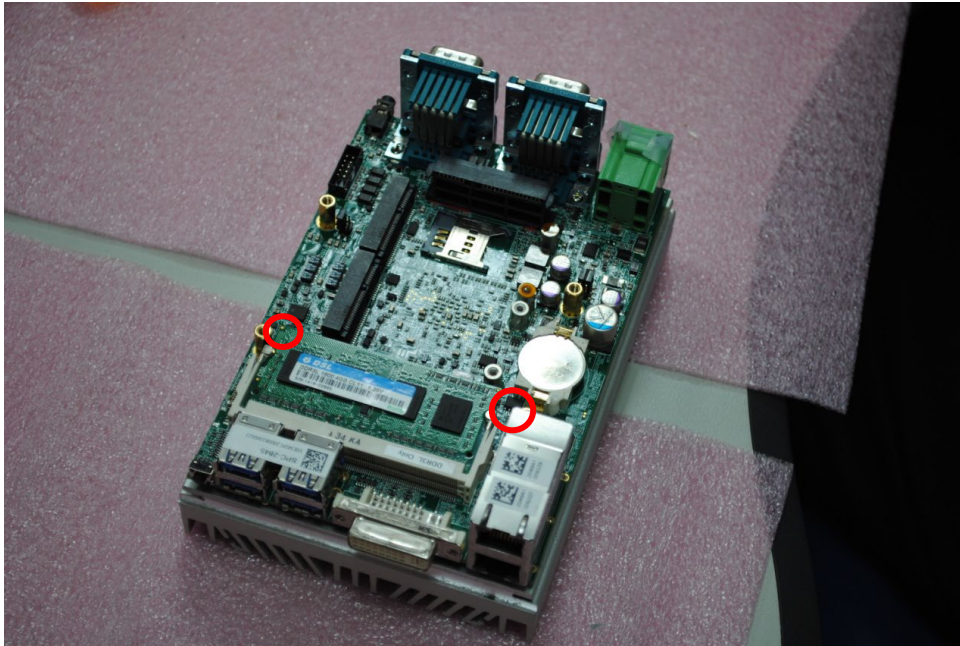



## 3.3 Installing SSD/HDD

1. Take SSD module and SSD Bracket



2. Match SSD bracket hole and SSD screw hole.



3. Locked 4 pcs M3 screw in SSD screw hole.

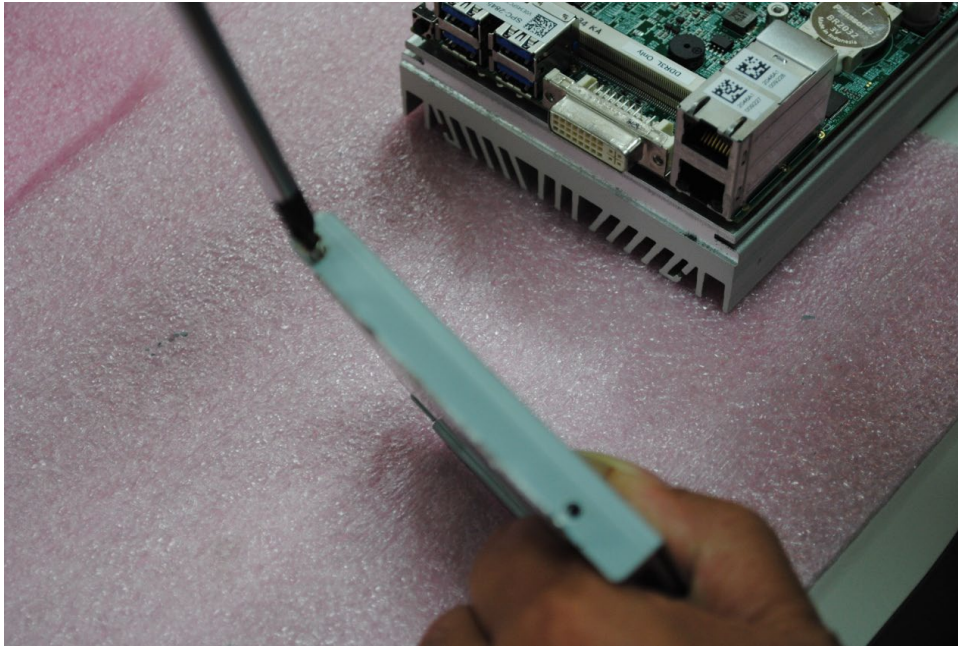

4. Insert SSD SATA connector into PCB SATA socket.

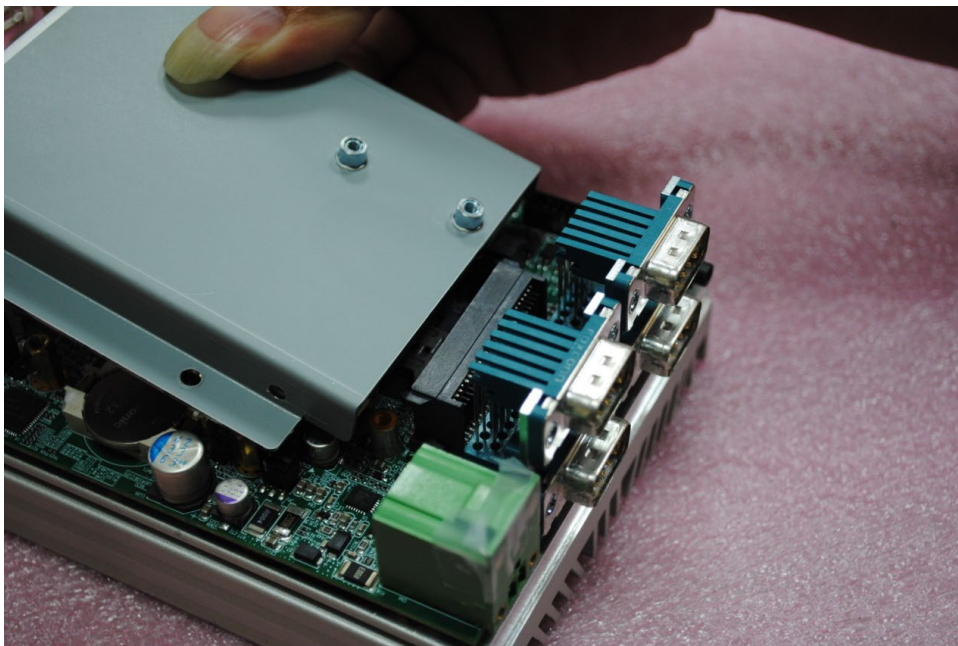

5. Locked 4 pcs M3 PH screw into spacer.



### 3.4 Installing Mini PCIe Module

1. Insert miniPCIe module into miniPCIe socket

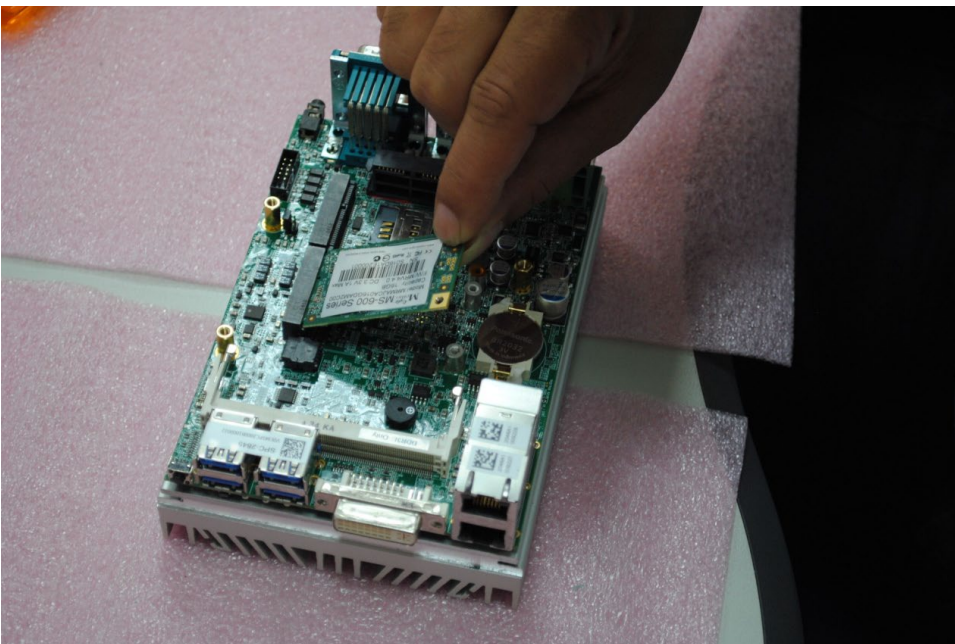

2. Locked 2 pcs M2.5 PH screw into PCB spacer



### 3.5 Mount Your SPC-2000

1. Locked 4 pcs M3 screw both side



2. Locked 4 pcs M3 PH screw



# CHAPTER 4 BIOS AND DRIVER

## 4.1 BIOS Settings

The board uses UEFI BIOS that is use Serial Peripheral Interface (SPI) Flash. The SPI Flash contains the BIOS Setup program, POST, the PCI auto-configuration utility, LAN, EEPROM information, and Serial port support. The BIOS setup program is accessed by pressing the <Del> key after the Power-On Self-Test (POST) memory test begins and before the operating system boot begins. The menu bar is shown below.



Figure 1-1: BIOS Menu Bar

## 4.2 Main Menu

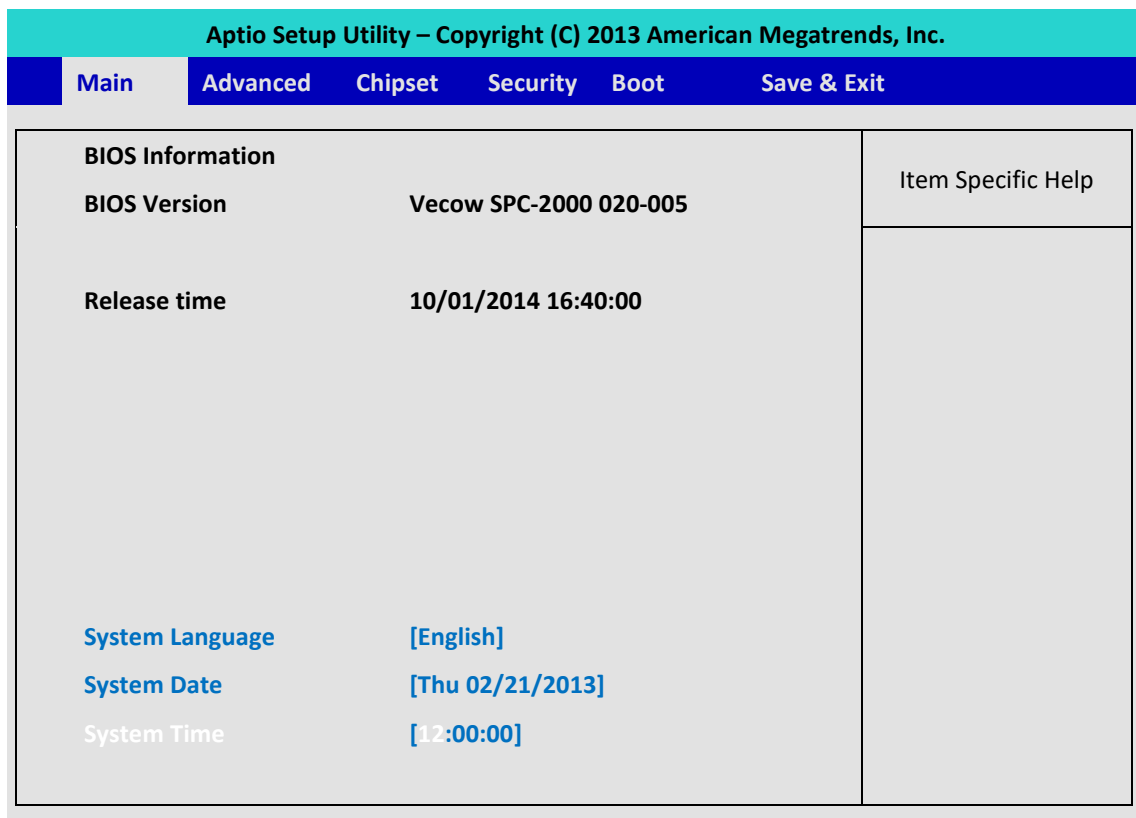

Figure 1-2: BIOS Main screen

**System Time / Date :** Press “TAB” key to switch sub-items of value .Then press “ +” key or “-” key number key for modify value.

In this page , you could make sure you CPU type and DRAM type that you are install into this system.

## 4.3 Advanced Function

### 4.3.1 ACPI Setting

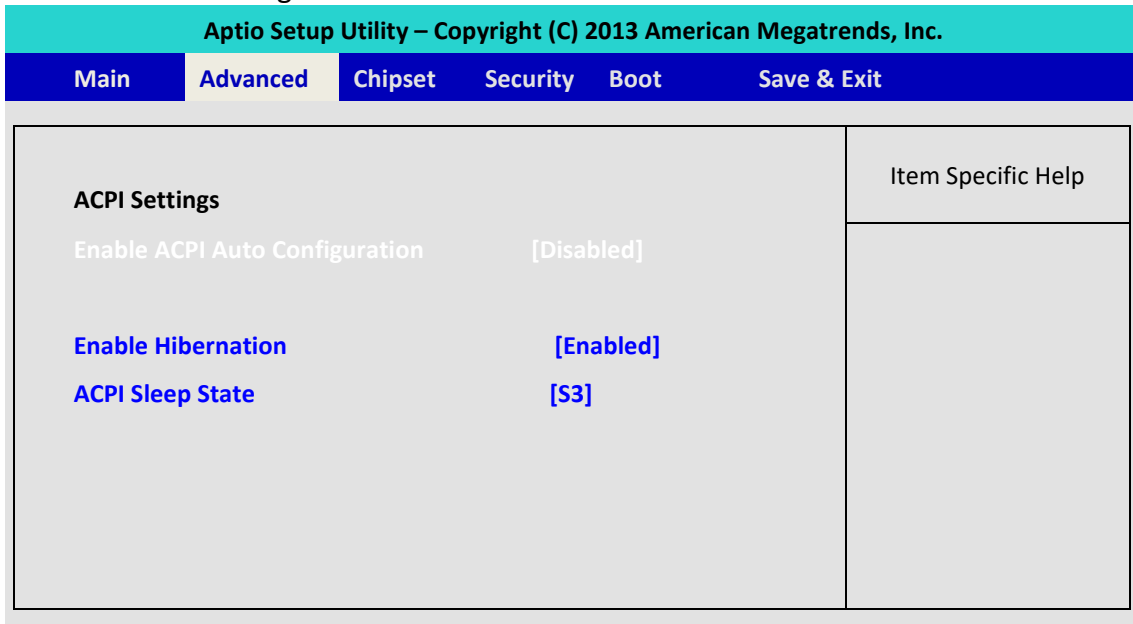

Figure 1-3: ACPI Setting setup screen

**Enable ACPI Auto Configuration:** This system support ACPI function as auto process. You should Enable / Disable that depend as your O.S.

**Enable Hibernation:** It is able to use Hibernate function if O.S support. But some Operation system maybe not effective with this function.

**ACPI Sleep state:** Select sleep state while SUSPEND button pressed.

### 4.3.2 Serial Port 1 Configuration

Advanced->IT8786 Super IO Configuration->Serial Port 1 Configuration

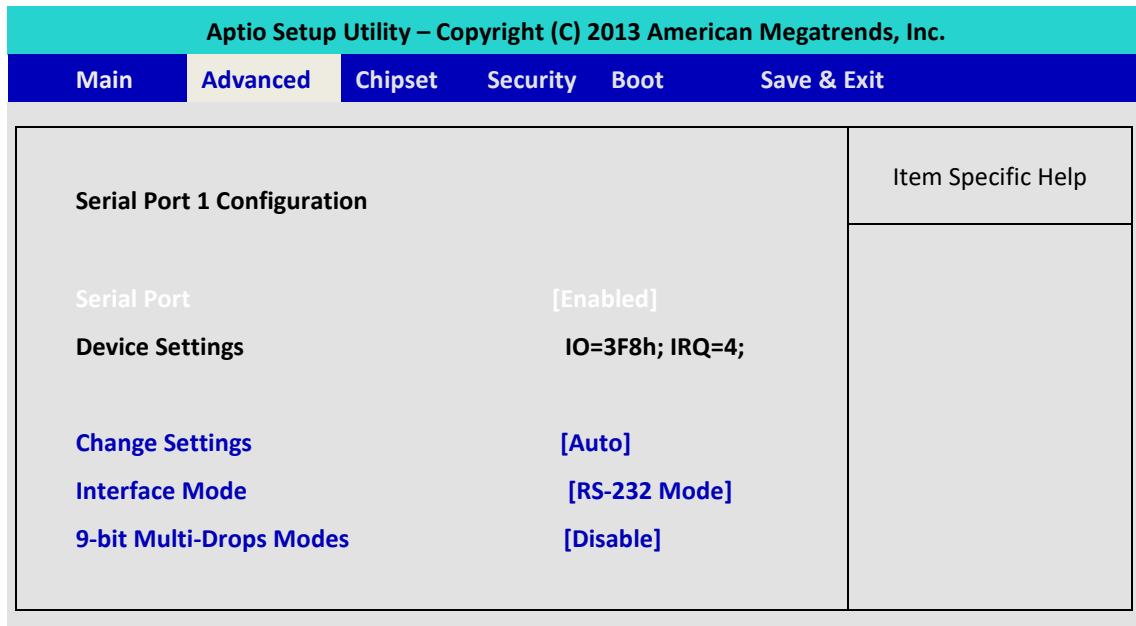

Figure 1-7: Serial Port 1 Setup screen

**Serial Port :**

Enable or Disable Serial port.

**Device Setting:**

Current IO addresses and interrupts resource of Serial Port.

**Change Settings :**

Select another device setting.

Here have 6 options :

- Auto
- IO=3F8h; IRQ=4;
- IO=3F8h; IRQ=3,4,5,6,7,8,9,10,11,12;
- IO=2F8h; IRQ=3,4,5,6,7,8,9,10,11,12;
- IO=3E8h; IRQ=3,4,5,6,7,8,9,10,11,12;
- IO=2E8h; IRQ=3,4,5,6,7,8,9,10,11,12;

**Interface Mode:**

Select UART transfer and receive protocol

Here have 3 options :

- RS-232 Mode
- RS-422 Mode
- RS-485 Mode

**9-bit Multi-Drops Mode:**

Enable/Disable Multi Drops mode to use the enhance function of RS-485 as multi device connection.



### 4.3.3 Serial Port 2 Configuration

Advanced->IT8786 Super IO Configuration->Serial Port 2 Configuration

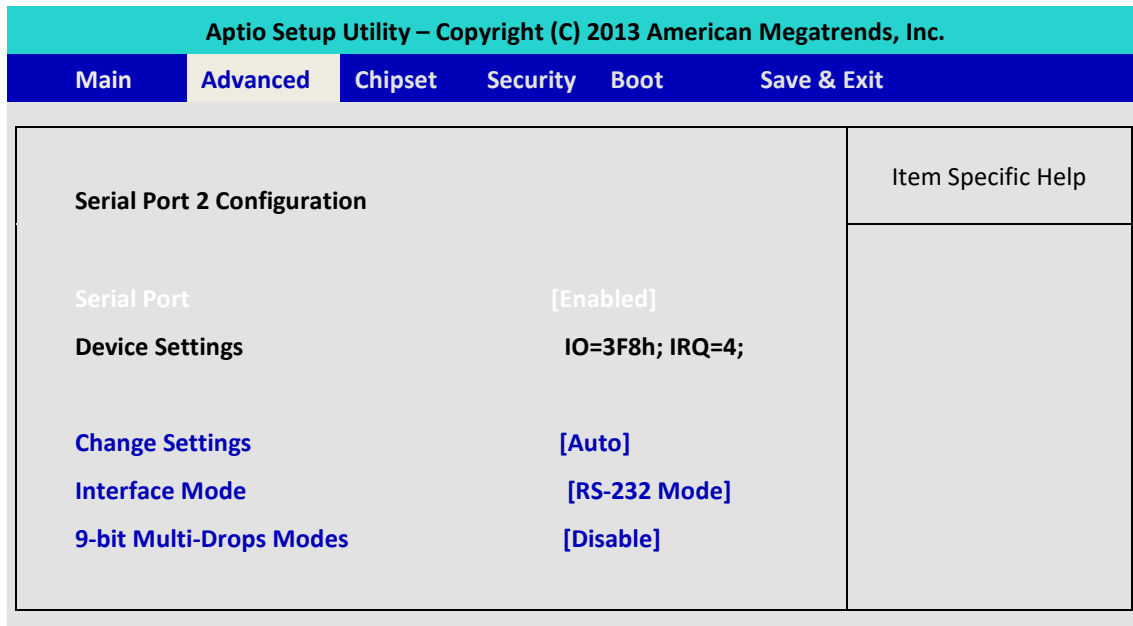

Figure 1-7: Serial Port 1Setup screen

**Serial Port :**

Enable or Disable Serial port.

**Device Setting:**

Current IO addresses and interrupts resource of Serial Port.

**Change Settings :**

Select another device setting.

Here have 6 options :

Auto

IO=3F8h; IRQ=4;

IO=3F8h; IRQ=3,4,5,6,7,8,9,10,11,12;

IO=2F8h; IRQ=3,4,5,6,7,8,9,10,11,12;

IO=3E8h; IRQ=3,4,5,6,7,8,9,10,11,12;

IO=2E8h; IRQ=3,4,5,6,7,8,9,10,11,12;

**Interface Mode:**

Select UART transfer and receive protocol

Here have 3 options :

RS-232 Mode

RS-422 Mode

RS-485 Mode

**9-bit Multi-Drops Mode:**

Enable/Disable Multi Drops mode to use the enhance function of RS-485 as multi device connection.

### 4.3.4 Serial Port 3 Configuration

Advanced->IT8786 Super IO Configuration->Serial Port 3 Configuration

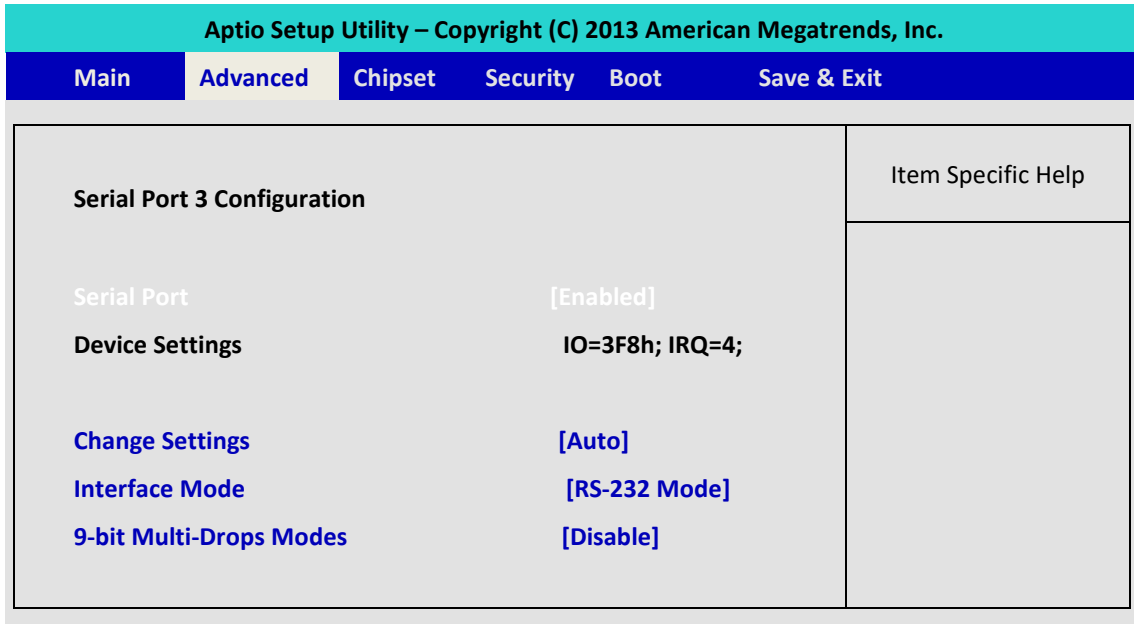

Figure 1-7: Serial Port 1Setup screen

**Serial Port :**

Enable or Disable Serial port.

**Device Setting:**

Current IO addresses and interrupts resource of Serial Port.

**Change Settings :**

Select another device setting.

Here have 6 options :

- Auto
- IO=3F8h; IRQ=4;
- IO=3F8h; IRQ=3,4,5,6,7,8,9,10,11,12;
- IO=2F8h; IRQ=3,4,5,6,7,8,9,10,11,12;
- IO=3E8h; IRQ=3,4,5,6,7,8,9,10,11,12;
- IO=2E8h; IRQ=3,4,5,6,7,8,9,10,11,12;

**Interface Mode:**

Select UART transfer and receive protocol

Here have 3 options :

- RS-232 Mode
- RS-422 Mode
- RS-485 Mode

**9-bit Multi-Drops Mode:**

Enable/Disable Multi Drops mode to use the enhance function of RS-485 as multi device connection.

### 4.3.5 Serial Port 4 Configuration

Advanced->IT8786 Super IO Configuration->Serial Port 4 Configuration

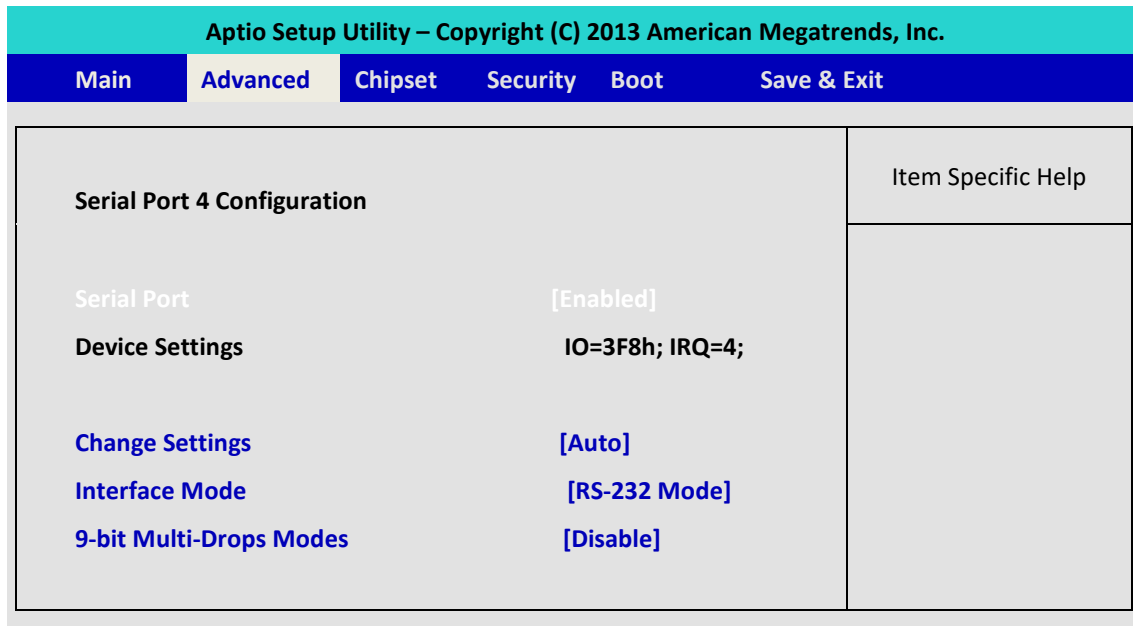

Figure 1-7: Serial Port 1Setup screen

**Serial Port :**

Enable or Disable Serial port.

**Device Setting:**

Current IO addresses and interrupts resource of Serial Port.

**Change Settings :**

Select another device setting.

Here have 6 options :

Auto

IO=3F8h; IRQ=4;

IO=3F8h; IRQ=3,4,5,6,7,8,9,10,11,12;

IO=2F8h; IRQ=3,4,5,6,7,8,9,10,11,12;

IO=3E8h; IRQ=3,4,5,6,7,8,9,10,11,12;

IO=2E8h; IRQ=3,4,5,6,7,8,9,10,11,12;

**Interface Mode:**

Select UART transfer and receive protocol

Here have 3 options :

RS-232 Mode

RS-422 Mode

RS-485 Mode

**9-bit Multi-Drops Mode:**

Enable/Disable Multi Drops mode to use the enhance function of RS-485 as multi device connection.

### 4.3.6 PPM Configuration

Advanced->PPM Configuration

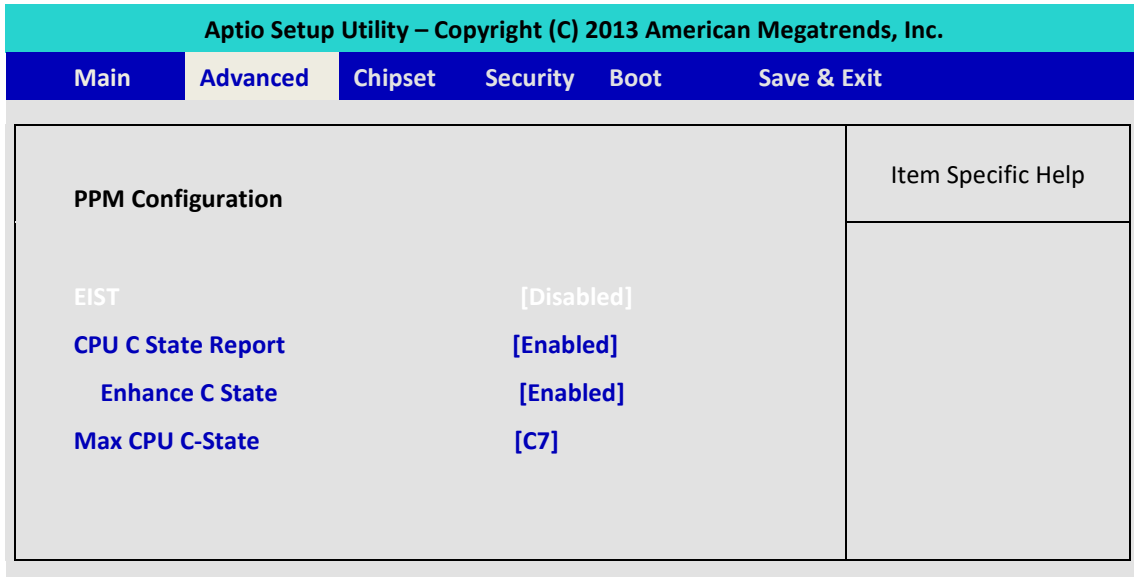

Figure 1-4: Trusted Computing setup screen

**EIST** : Enables or Disables Intel Speed function , once you enabled it , you could use the Intel Turbo Boost software to monitor you CPU performance. Please refer to CPU check list.

### 4.3.7 CPU Configuration

Advanced->CPU Configuration->Socket 0 CPU Information

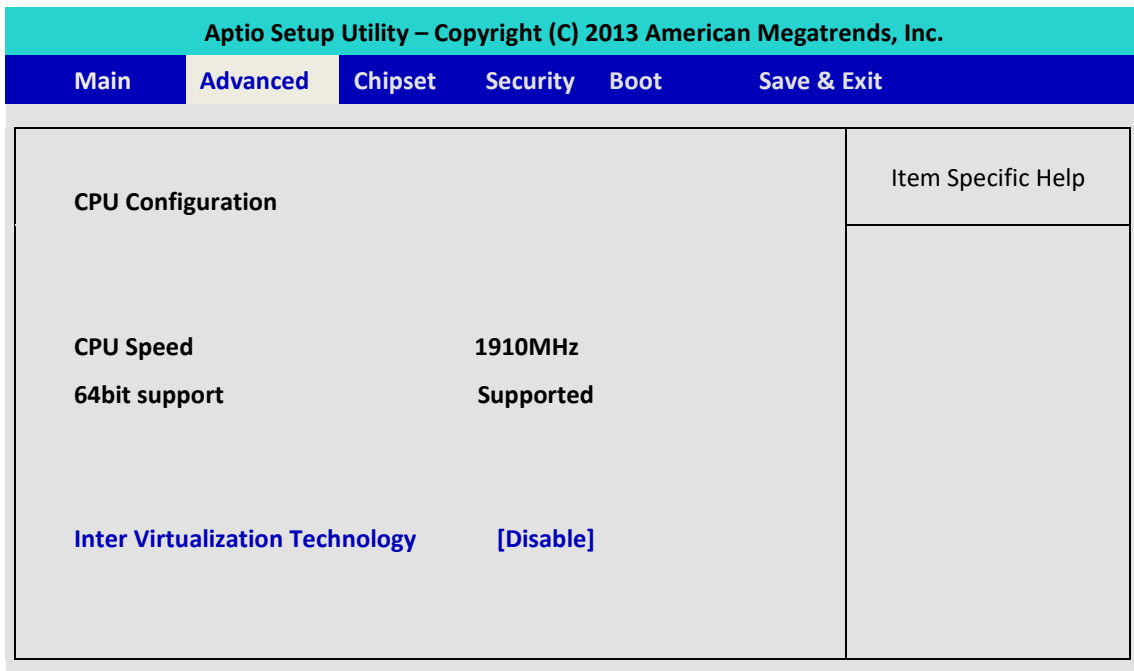

Figure 1-5: Trusted Computing setup screen

**Intel Virtualization Technology:**

This for for Virtualization Application or platform usage, when enabled, a VMM can utilize the additional hardware capabilities provided by Vanderpool Technology,

4.3.8 IDE Configuration

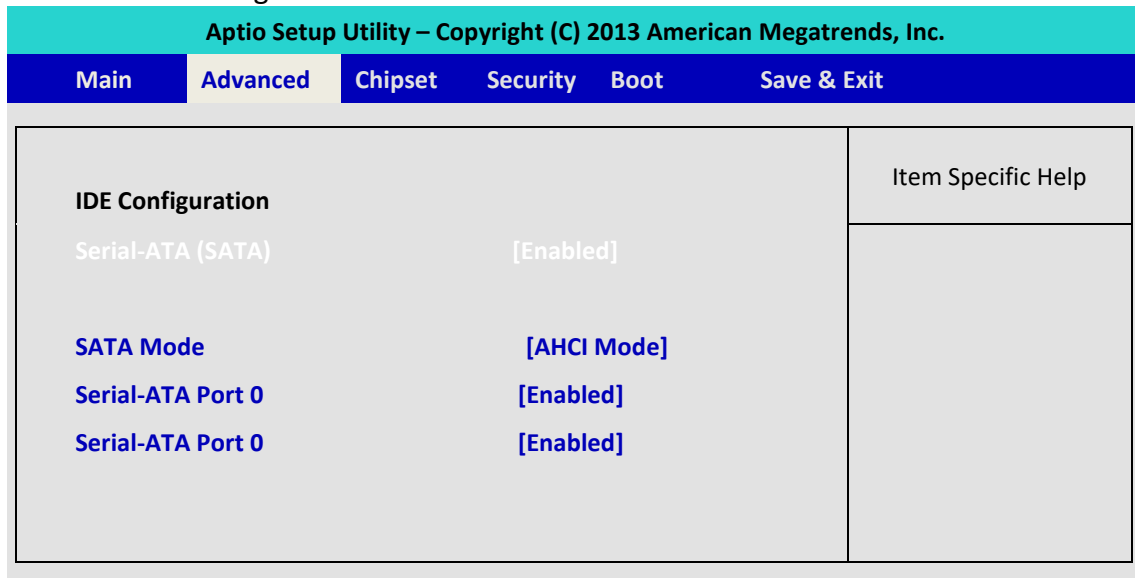

Figure 1-6: SATA Configuration setup screen

**Serial-ATA(SATA) :**

Enables or Disables integrate SATA controller for Storage device use.

**SATA Mode Selection:**

Determines how the SATA transfer mode for operate. Here have three option for choice [IDE] / [AHCI] .

**Serial Port 0~1 :**

This system offers two SATA port for connection SATA device.

## 4.4 Chipset Function

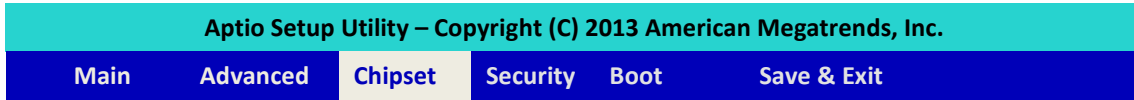

### 4.4.1 Display Configuration

Chipset->North Bridge->Intel IGD Configuration->Primary Display

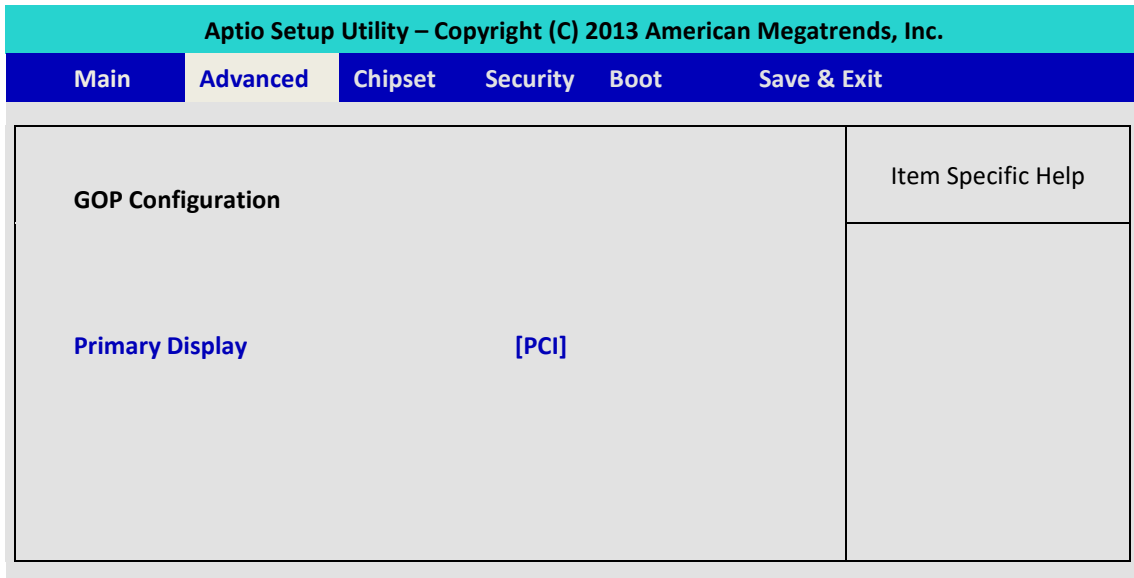

Figure 1-11: Network Setup screen

#### Primary Display :

Select which Display module you would like to you on current system.

[PCI] : System display function will be change to internal PCI or PCIe bus.

[IGD] : Use Internal Intel HD Graphics unit for unique display output.

### 4.4.2 Power Loss Configuration

Chipset->South Bridge

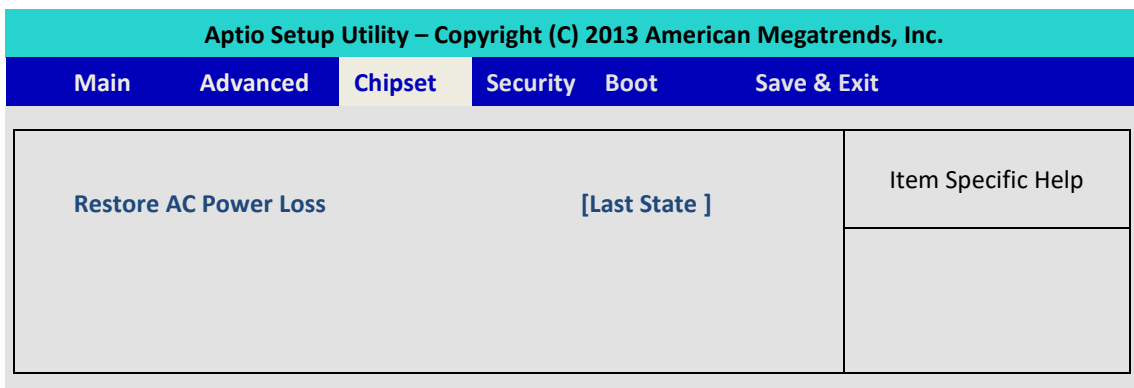

Figure 1-12: Power Loss Setup screen

#### Restore AC Power Loss :

[Power Off ] : When plug-in the power source , system will keep on SB mode.

[Power On ] : When plug-in the power source , system will auto booting .

[Last State ] : When plug-in the power source , system will keep on last power status.

## 4.5 Boot Function



### 4.5.1 Change Boot Configuration

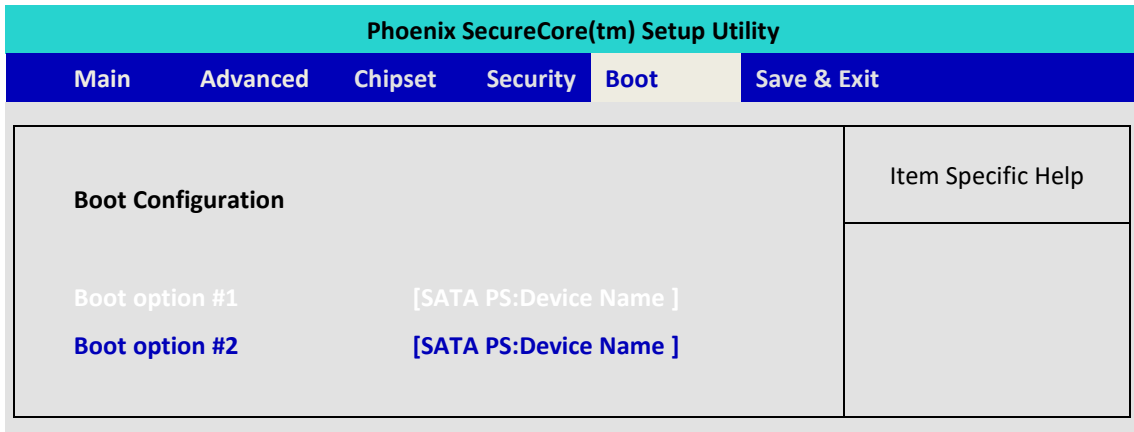
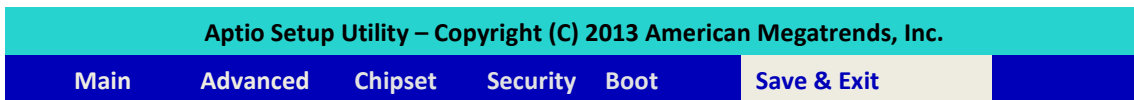

Figure 1-13 Boot Setup screen

**Boot option:**

When you press “Enter” , you can select which device you would like to boot.

## 4.6 Save & Exit



### 4.6.1 Reload Default BIOS Value

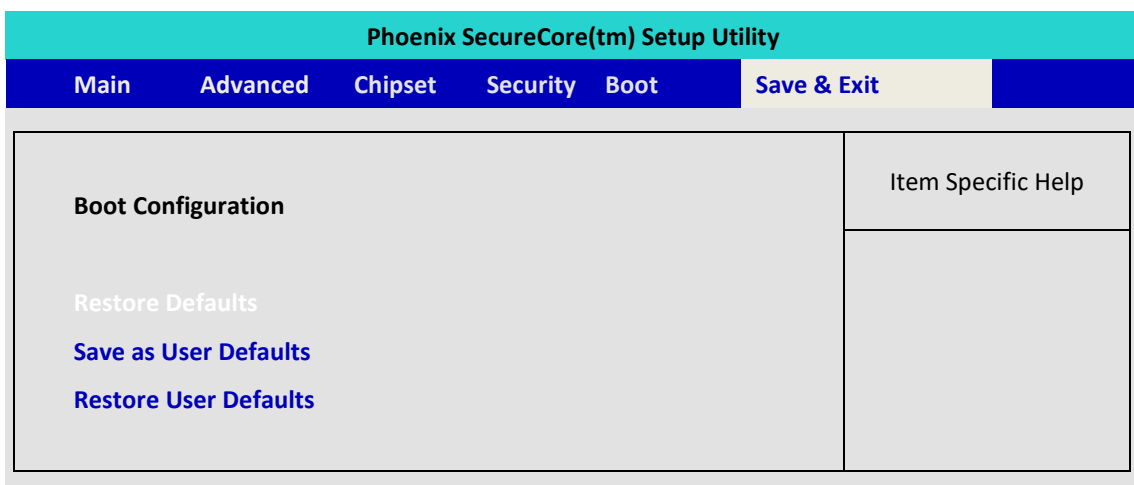

Figure 1-13 Boot Setup screen



**Restore Default:**

Use the function to restore all BIOS setting, but not include administrator password and system RTC value.

**Save as Use Default:**

Users can use this function to match the target system.

**Restore as Use Default:**

Restore all BIOS setting to User Default.

# Appendix A: ISOLATED DIO GUIDE

## A. SIO Pin Definition

IO Pin	GPIO 77~74	GPIO 73~70
Base Adr.	0xA06[7:4]	0xA06[3:0]
Usage	Input	Output

## B. Function Description

The SPC-2000 offers a 8-bit DIO (4-DI / 4-DO) DB9 connector.

Each bit of DI and DO equipped with a photo-coupler for isolated protection.

All IO pins are fix by Hardware design that cannot change in/out direction in runtime process.

The definition is shown below:

## C. Register Allocation

```
#define LOGIC_DEVICE_ADDRESS    0x07
#define LOGIC_DEVICE_GPIO      0x07
#define LOGIC_DEVICE_WDT       0x07 ( Use same Group Table)
#define GPIO7_IO_Dir           0xCE
```

## D. Set I/O Direction

```
Setdata ( GPIO7_IO_Dir,0x0F );
```

Low level [0] : The I/O pin set as input.

High level [1] : The I/O pin set as output.

## E. Output Data

The data format is four bit , please mask upper four bit to avoid some run-time error.

```
byte testdata;
```

```
outport ( DIO_Port , 0x0F&testdata );
```

## F. Input Data

You need shift right four bit to get input value.

```
inportb(DIO_Port)>>4;
```

# Appendix B: WDT FUNCTION

## A. Function Description

The WDT are using internal Super IO function. However, you must entry super I/O configuration mode to set it.

**Super I/O special address port = 0x2E**

**Super I/O special data port = 0x2F**

GPIO Logical device is 0x07

## B. Entry Functions

### 1. Entry MB PnP mode.

```
//write twice 0x87 value.
outportb(Super I/O special address port, 0x87);
outportb(Super I/O special address port, 0x01);
outportb(Super I/O special address port, 0x55);
outportb(Super I/O special address port, 0x55);
```

### 2. Located on Logical Device 7(LOGIC\_DEVICE\_WDT)

```
//write 0x07 on Reg [0x07] , this setup must follow Step A. that can be workable.
outportb(Super I/O special address port, 0x07);
outportb(Super I/O special data port, 0x07);
```

### 3. Config the WDT register

```
outb(WDT_Config,SPECIAL_ADDRESS_PORT);
outb(WDT_As_Second|WDT_Pin_PWRGD,SPECIAL_DATA_PORT);
```

### 4. Start WDT Time out value

Here have 2 Byte for WDT timing count, MSB and LSB should be write the value separate.



```
outb(WDT_TimeOut_LSB,SPECIAL_ADDRESS_PORT);
outb(WDT_TimeOutValue,SPECIAL_DATA_PORT);
```

# Appendix C: WIN7 INSTALLATION GUIDE

Vecow's ultra-compact box PC, SPC-2000 series, offers the best possible hardware specification in the market. It supports four USB 3.0 ports. Although USB 3.0 is compatible to USB 2.0, it requires USB 3.0 driver for activation. Windows 8 has built-in USB 3.0 driver, and the user can smoothly install OS. In Windows 7, however, USB 3.0 driver is not included and requires extra steps. This document provides options and steps for user to install Operation System and activate USB 3.0 ports in Windows 7 environments. This installation process focuses on Windows 7, WinServer2008 R2 of Windows System and Fedora 21, and Ubuntu 12.04 LTS Linux distribution.

## Win7 Pre-installed by Vecow

Vecow has Customer License Agreement with Microsoft and can help to purchase and pre-install OS for all Vecow products. Along with system burn-in test, USB 3.0 driver will be installed and checked before shipping. You are welcome to include storage device and Operation System when ordering products. Please contact Vecow sales team for more details.

## Win7 OS installation via DVD

1. Connect a **USB hub** to the following port and connect input devices

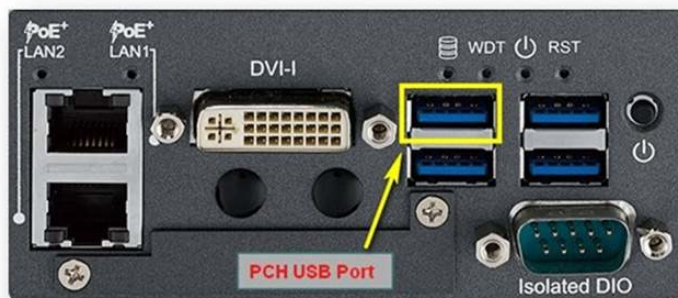

2. Change the following BIOS settings  
Advanced -> **CSM Configuration** -> Storage -> Legacy Only  
Advanced -> **USB Configuration** -> Legacy USB Support -> Enabled  
Advanced -> **USB Configuration** -> XHCI Hand-off -> Disabled  
Advanced -> **USB Configuration** -> EHCI Hand-off -> Enabled  
Chipset -> South Bridge -> USB Configuration -> XHCI Mode -> Disabled  
Chipset -> South Bridge -> **USB Configuration** -> USB 2.0(EHCI) Support -> Enabled  
Save & Exit -> Save Changes and Exit -> Yes
3. Connect all USB devices (DVD/Keyboard/Mouse) to the PCH USB port.  
Before OS/USB3 drivers are properly installed, only PCH USB port can be recognized by Legacy OS kernel. It is suggested to use a USB hub for the PCH USB port and connect all USB devices to the hub.
4. Insert Win7 Install CD and booting up from CD-Device.

Generally, the OS DVD will install windows automatically on whole new system. If you have two bootable devices that connect to the system, please make sure which one is using on O.S install.

5. Verify the BIOS setting again.
6. Complete the O.S install process.
7. Driver Installation

In addition to USB3.0, you also need to install all the drivers to make the system functional.

- Chipset Driver
- LAN driver
- USB 3.0 driver
- Graphics ( .NET 4.0 required )

All driver packages could be found at Vecow web site.

### **Win7 System image file**

- Include USB 3.0 driver in Win7 (ref. to above steps)
- Use Ghost to create Disk Image file
- Restore system from Disk Image file in different storage devices
- Install the storage device with disk image file to SPC-2000
- Repeat above steps and apply to different SPC-2000 units
- Suggested approach for installing Win7 in several SPC-2000

\*\* If more help is needed, please contact Vecow Technical Support